

**TECHNICAL MANUAL**

**OPERATORS, ORGANIZATIONAL, DIRECT SUPPORT  
AND GENERAL SUPPORT MAINTENANCE MANUAL  
FOR  
LOW CAPACITY TACTICAL RADIO RELAY SYSTEM**

---

**H E A D Q U A R T E R S , D E P A R T M E N T O F T H E A R M Y**

**OCTOBER 1974**

**OPERATOR'S, ORGANIZATIONAL, DIRECT SUPPORT, AND  
GENERAL SUPPORT MAINTENANCE MANUAL FOR  
LOW CAPACITY TACTICAL RADIO RELAY SYSTEM**

	Paragraph	Page
CHAPTER 1. INTRODUCTION		
Scope .....	1-1	1-1
Indexes of publications .....	1-2	1-1
Forms and records .....	1-3	1-1
Reporting of errors .....	1-4	1-1
Section 2. BASIC PULSE-CODE MODULATION PRINCIPLE		
I. Introduction .		
General .....	2-1	2-1
Principles of multiplexing .....	2-2	2-1
II. Principles of Pulse-Code Modulation		
General .....	2-3	2-2
Voice transmission by pulse-code modulation .....	2-4	2-2
CHAPTER 3. COMPONENT DESCRIPTION AND DATA		
Multiplexer TD-204/U .....	3-1	3-1
Multiplexer TD-764/G .....	3-2	3-1
Restorer, Pulse Form TD-206/G .....	3-3	3-4
Multiplexer TD-660/G or TD-660A/G .....	3-4	3-4
Converter, Telephone Signal CV-1648/G .....	3-5	3-6
Radio Set AN/GRC-103(V)1 .....	3-6	3-7
Antenna Assembly .....	3-7	3-9
TA-312/PT and LS-147C/FI .....	3-8	3-12
Transmission Cable and Test Set, Telephone AN/PTM-7 .....	3-9	3-14
4. ASSEMBLAGE DESCRIPTION AND DATA		
General Characteristics .....	4-1	4-1
Terminal Set, Telephone AN/TCC-65 .....	4-2	4-20
Repeater Set, Radio AN/TRC-113 .....	4-3	4-31
Radio Terminal Set AN/MRC-1165(V) .....	4-4	4-35
Radio Terminal Sets AN/MRC-126 and AN/MRC-127 .....	4-5	4-38
Radio Terminal Set AN/TRC-145 .....	4-6	4-43
5. ASSEMBLAGE CAPABILITIES		
General .....	5-1	5-1
Terminal Set, Telephone AN/TCC-65 .....	5-2	5-1
Repeater Set, Radio AN/TRC-113 .....	5-3	5-1
Radio Terminal Set AN/MRC-115(V) .....	5-4	5-1
Radio Terminal Sets AN/MRC-126 and AN/MRC-127 .....	5-5	5-1
Radio Terminal Set AN/TRC:145 .....	5-6	5-1
6. SYSTEM DESCRIPTION AND DATA		
Purpose and use .....	6-1	6-1
System assemblages .....	6-2	6-1
Capabilities and limitations .....	6-3	6-6
7. MAINTENANCE CONCEPT		
General .....	7-1	7-1
Organizational maintenance .....	7-2	7-1

	Paragraph	Page
Direct support maintenance .....	7-3	7-1
General support maintenance .....	7-4	7-1
Depot maintenance .....	7-5	7-1
Appendix REFERENCES .....		A-1
GLOSSARY .....		G-1

## LIST OF ILLUSTRATIONS

Number	Title	Page
2-1	Simplified telephone system showing simple tdm 2-1	
2-2	Simplified 12-channel tdm system.....	2-2
3-1	Multiplexer TD-204/U .....	3-2
3-3	Restorer, Pulse Form TD-206/G .....	3-3
3-4	Multiplexer TD-660/G .....	3-5
3-5	Converter, Telephone Signal CV-1648/G.....	3-7
3-6	Radio Set AN/GRC-103(V)1, less antenna, mast and minor components .....	3-9
3-7	Antenna AS-1852/GRC-103(V).....	3-11
3-8	Antenna Elements AS-2194/GRC-103(V) and AS-2195/GRC-103(V).....	3-12
3-9	Telephone Set TA-312/PT and Intercommunication Station LS-147C/FI .....	3-13
3-10	Test Set, Telephone AN/PTM-7 .....	3-14
4-1	Terminal, Telephone AN/TCC-65, rear curbside view (serial No. 1 through 19).....	4-2
4-2	Terminal, Telephone AN/TCC-65, front roadside view (serial No. 1 through 19).....	4-3
4-3	Terminal, Telephone AN/TCC-65, rear curbside view (serial No. 20 and above).....	4-4
4-4	Terminal, Telephone AN/TCC-65, front roadside view (serial No. 20 and above).....	4-5
4-5	Repeater Set, Radio AN/TRC-113, rear curbside view .....	4-6
4-6	Repeater Set, Radio AN/TRC-113, front roadside view .....	4-7
4-7	Radio Terminal Set AN/MRC-115(V), prepared for transit.....	4-8
4-8	AN/MRC-115(V) trailer, tarpaulin removed, front curbside view .....	4-9
4-9	AN/MRC-116(V) trailer, tarpaulin removed, rear roadside view .....	4-10
4-10	Radio Terminal Set AN/MRC-126 or AN/MRC-127, prepared for transit, rear curbside view.....	4-11
4-11	Radio Terminal Set AN/MRC-126 or AN/MRC-127, prepared for transit, front roadside view.....	4-12
4-12	Radio Terminal Set AN/MRC-126, tarpaulin removed, rear curbside view .....	4-13
4-14	Radio Terminal Set AN/MRC-127, tarpaulin removed, rear curbside view .....	4-15
4-15	Radio Terminal Set AN/MRC-127, tarpaulin removed, front roadside view .....	4-16
4-16	Radio Terminal Set AN/TRC-145 (serial No. 1 through 46), rear curbside view.....	4-17
4-17	Radio Terminal Set AN/TRC-145 (serial No. 1 through 46), front roadside view .....	4-18
4-18	Radio Terminal Set AN/TRC-145 (serial No. 47 and above), front curbside view .....	4-19
4-19	Radio Terminal Set AN/TRC-145 (serial No. 47 and above), rear roadside view .....	4-20
4-20	Terminal, Telephone AN/TCC-65, interior front view (serial No. 1 through 19) .....	4-21
4-21	Terminal, Telephone AN/TCC-65, interior front roadside view (serial No. 1 through 19).....	4-22
4-22	Terminal, Telephone AN/TCC-65, interior rear roadside view (serial No. 1 through 19).....	4-23
4-23	Terminal, Telephone AN/TCC-65, interior front curbside view (serial No. 1 through 19) .....	4-24
4-24	Terminal, Telephone AN/TCC-65, interior rear curbside view (serial No. 1 through 19).....	4-25
4-26	Terminal, Telephone AN/TCC-65, interior front view (serial No. 20 and above).....	4-26
4-26	Terminal, Telephone AN/TCC-65, interior front roadside view (serial No. 20 and above).....	4-27
4-27	Terminal, Telephone AN/TCC-65, interior rear roadside view (serial No. 20 and above).....	4-28
4-28	Terminal, Telephone AN/TCC-65, interior front curbside view (serial No. 20 and above).....	4-29
4-29	Terminal, Telephone AN/TCC-65, interior rear curbside view (serial No. 20 and above).....	4-30
4-30	Repeater Set, Radio AN/TRC-113, interior front view.....	4-31
4-31	Repeater Set, Radio AN/TRC-113, interior front roadside view .....	4-32
4-32	Repeater Set, Radio AN/TRC-113, interior rear roadside view.....	4-33
4-33	Repeater Set, Radio AN/TRC-113, interior front curbside view .....	4-34
4-34	Repeater Set, Radio AN/TRC-113, interior rear curbside view .....	4-35
4-35	AN/MRC-116(V) trailer, front view .....	4-36
4-36	AN/MRC-115(V) assemblage with canopy support frame erected and blowers installed.....	4-37
4-37	AN/MRC-115(V) with tarpaulin in place.....	4-38
4-38	Radio Terminal Set AN/MRC-126 or AN/MRC-127, interior roadside view.....	4-39
4-39	Radio Terminal Set AN/MRC-126, interior curbside view .....	4-40
4-40	Radio Terminal Set AN/MRC-127, interior curbside view .....	4-41
4-41	Radio Terminal Set AN/MRC-126 or AN/MRC-127, tarpaulin removed and tarpaulin support frame raised, front roadside view .....	4-42

LIST OF ILLUSTRATIONS-Continued

Number	Title	Page
4-42	Radio Terminal Set AN/MRC-126 or AN/MRCO127, tarpaulin installed, rear curbside view.....	4-43
4-43	Radio Terminal Set AN/TRC-14 (serial No. 1 through 46), interior front view.....	4-44
4-44	Radio Terminal Set AN/TRC-145 serial No. 1 through 46), interior front roadside view).....	4-45
4-45	Radio Terminal Set AN/TRC-145 (serial No. 1 through 46), interior rear roadside view.....	4-46
4-46	Radio Terminal Set AN/TRC-145 (serial No. 1 through 46), interior front curbside view.....	4-47
4-47	Radio Terminal Set AN/TRC-145 (serial No. 1 through 46), interior rear curbside view).....	4-48
4-48	Radio Terminal Set AN/TRC-145 (serial No. 47 and above), interior front view).....	4-49
4-49	Radio Terminal Set AN/TRC-145 (serial No. 47 and above), interior front roadside view.....	4-50
4-50	Radio Terminal Set AN/TRC-145 (serial No. 47 and above), interior rear roadside view.....	4-51
4-51	Radio Terminal Set AN/TRC-145 (serial No. 47 and above), interior front curbside view.....	4-52
4-52	Radio Terminal Set AN/TRC-145 (serial No. 47 and above), interior rear curbside view.....	4-53
5-1	Typical 6- or 12-channel multiplex carrier systems.....	6-2
5-2	6- or 12-channel nonsecure cable terminal application, block diagram.....	5-2
5-3	6-, 12-, 24-, or 48-channel cable repeater application, block diagram.....	5-3
5-4	Typical 6- or 12-channel radio repeater application, block diagram.....	5-3
5-5	12-channel, cable-to-radio conversion application, block diagram.....	5-3
5-6	6- or 12-channel nonsecure radio terminal application, block diagram.....	5-3
5-7	6- or 12-channel secure radio terminal application, block diagram.....	5-4
5-8	6- or 12-channel secure cable terminal application, block diagram.....	5-4
6-1	Typical employment of low capacity tactical radio relay system in tactical field army.....	6-2
6-2	Typical applications of AN/TCC-65.....	6-3
6-3	Typical applications of AN/TRC-113.....	6-4
6-4	Typical applications of AN/MRC-126 or AN/MRC-127.....	6-5
6-5	Typical applications of AN/TRC-145.....	6-5
FO-1	Voice transmission by pulse code modulation.....	



## CHAPTER 1 INTRODUCTION

---

### 1-1. Scope

This manual describes the Low Capacity Tactical Radio Relay System and its relationship to other systems that comprise the Army Tactical Area Communications Systems (ATACS). Paragraphs 2-1 through 2-4 describe the fundamental principles of time division multiplexing (tdm) and pulse-code modulation (pcm) employed in the system. This manual also provides a brief description of each type of component used in the system, the basic technical characteristics of each component, and their interrelationship and applications for various types of site configurations. A description of each assemblage that is an integral part of the Low Capacity Tactical Radio Relay System is provided. The individual capabilities of each assemblage are provided as well as their application and employment principles as interrelated to the system. Paragraphs 7-1 through 7-5 describe the maintenance concept employed in the system.

### 1-2. Indexes of Publications

a. *DA Pam 310-4.* Refer to the latest issue of DA Pam 310-4 to determine whether there are new editions, changes, or additional publications pertaining to the equipment.

b. *DA Pam 310-7.* Refer to DA Pam 310-7 to determine whether there are modification work orders (MWO's) pertaining to the equipment.

### 1-3. Forms and Records

a. *Reports of Maintenance and Unsatisfactory Equipment.* Maintenance forms, records, and reports which are to be used by maintenance personnel at all maintenance levels are listed in and prescribed by TM 38-750.

b. *Report of Packaging and Handling Deficiencies.* Fill out and forward DD Form 6 (Report of Packaging and Handling Deficiencies) as prescribed in AR 700-58/NAVSUP PUB 378/AFR 71-4/MCO P4030.29, and DSAR 4145.8.

c. *Discrepancy in Shipment Report (DISREP) (SP 361).* Fill out and forward Discrepancy in Shipment Report (DISREP) (SF 36i) as prescribed in AR 55-38/NAVSUPINST 4610.33/AFM 75-18/MCO P4610.19A, and DSAR 4500.15.

### 1-4. Reporting of Errors

Report of errors, omissions, and recommendations for improving this publication by the individual user is encouraged. Reports should be submitted on DA Form 2028 (Recommended Changes to Publications and Blank Forms), and forwarded direct to Commander, US Army Electronics Command, ATTN: AMSEL-MA-C, Fort Monmouth, NJ 07703.

**CHAPTER 2**  
**BASIC PULSE-CODE MODULATION PRINCIPLE**

**Section I. INTRODUCTION**

**2-1. General.**

a. The TD-204/U or TD-754/G, TD-206/G, and TD-660/G or TD-660A/G are pulse-code modulation components used as part of multichannel communication systems. These systems use radio or cable, or combinations of both as a transmission medium. The pcm components provide 6 or 12 audio channels in a single transmission channel.

b. In a 12-channel system, separate telephone signals are converted to pulse-code-modulation (tdm-pcm) pulse trains, for radio transmission. The two pulse trains are interleaved and transmitted over a single radio channel, and reconverted to telephone signals at a distant terminal.

c. The 12-channel system also provides for the capability for pulse trains to be reshaped and retimed at a repeater point in the system, and reconverted to telephone signals at another terminal. The repeater can therefore communicate in both directions, and with both terminals, and can be either a radio or cable repeater, or a combination for radio-to-cable conversion.

**2-2. Principles of Multiplexing**

a. *General.* Multiplexing is a technique used to transmit simultaneously several channels of voice or data over a radio or cable link. Frequency division-multiplexer (fdm) equipment utilizes a subcarrier frequency for each voice or data channel. In time-division-multiplexer equipment, each voice or data channel shares the transmission time and is intermittently transmitted.

b. *Time Division Multiplexing.*

(1) In time division multiplexing, each voice

channel is assigned a time interval in sequence with all other channels being multiplexed. These intervals are short and repeated at a high frequency. The samples taken from each channel are then converted to a form suitable for transmission in the selected medium. At the receiving terminal, the samples are demodulated and separated into their proper channels by a timing signal from the transmitting terminal.

(2) The simplified telephone circuit in figure 2-1 illustrates the time division principle. Switches S1 and S2 are synchronized such that both are in position A at the same time, and in position B at the same time. A telephone call made on line A is completed only when the switches are in position A. The telephone calls made on line B are completed only when the switches are in position B. When both lines are in use, the switches alternate between position A and position B. If the switching rate is low, both conversations will be garbled and unintelligible. If the rate is increased, the signals will be more intelligible. When the switching rate is higher than voice frequencies, the switching is not detectable.

(3) The circuit shown in figure 2-2 is a simplified 12-channel tdm system. The two switches are rotated in synchronism and each channel is sampled once during each revolution. Very little distortion occurs and the 12 conversations are intelligible when the rotation speed is rapid enough. Electronic switching is used in the pcm components described in this manual and 12 samples are taken in each time frame.

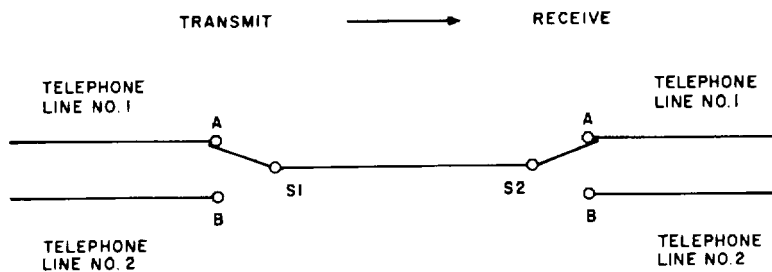

EL5895-458-14-TM-1

Figure 2-1. Simplified telephone system showing simple tam.

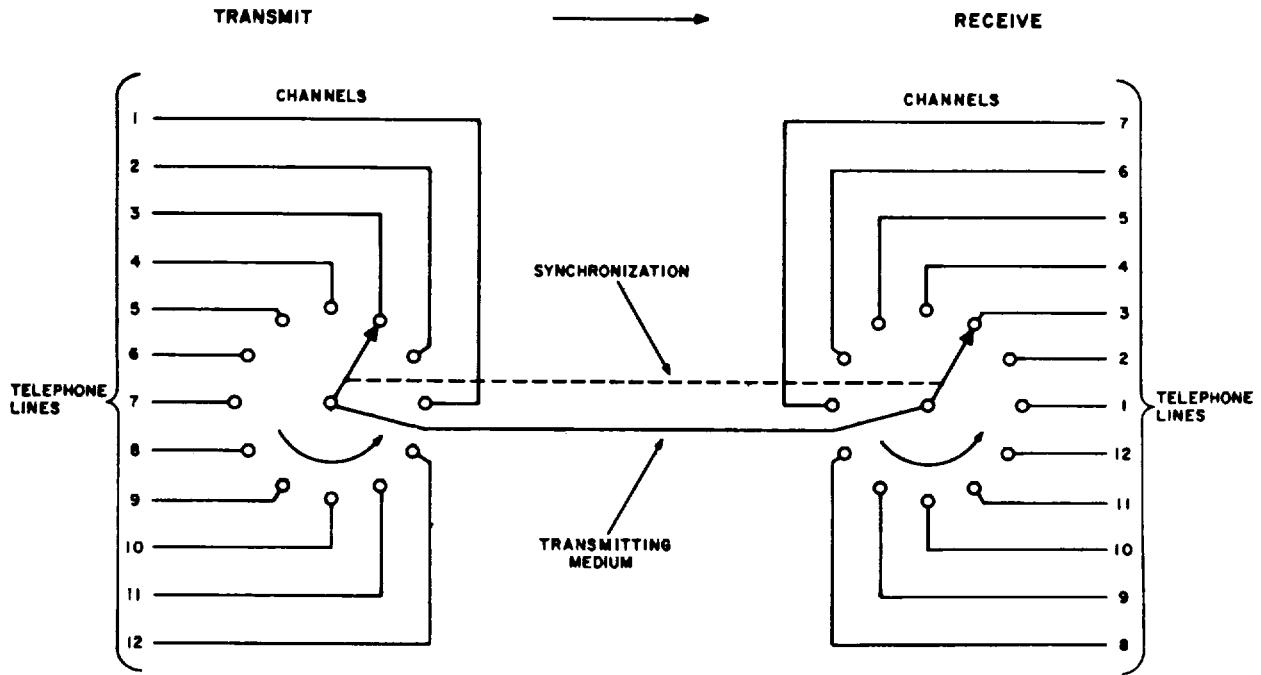

EL5895-458-14-TM-2

Figure 2-2. Simplified 12-channel tdm system.

**Section II. PRINCIPLES OF PULSE-CODE MODULATION**

**2-3. General**

Pulse-code modulation is a communication technique in which voice, data, or facsimile signals are converted into a series of digital pulse codes. Each pulse code represents signal amplitude at a particular instant and a series of pulse codes represents a complete waveform. Since the transmitted signal is in digital form, it is less susceptible to noise and distortion buildup over long distance lines, and may be regenerated at repeaters along the route without introducing additional distortion.

**2-4. Voice Transmission by Pulse Code Modulation**

(Fig FO-1.)

In the pcm process, standard amplitude levels are assigned and are represented by digital codes. The incoming voice waveform is sampled at a high rate, and each sample is converted to a pulse at the closest standard amplitude, producing a pulse-amplitude-modulated (pam) waveform. The standard amplitude pulses developed are then measured and converted to a binary pulse code for transmission. The pulse codes are decoded at the receiving station and reconverted to a pam waveform, which is then demodulated to produce approximately the original waveform. As the sampling frequency is increased, the waveform generated at the receiver more accurately resembles the original waveform.

**CHAPTER 3  
COMPONENT DESCRIPTION AND DATA**

**3-1. Multiplexer TD-204/U**

a. *Use.* Multiplexer TD-204/U (fig. 3-1) is a 12/24/48-channel pcm cable transmission interface unit. Its transmit section accepts tdm pcm output signals from a TD-660/U or TD 660A/G or from another TD-204/U or TD-7564/G, and processes these signals for cable transmission. The receive section accepts a pcm signal from the transmission cable, processes and retimes it. In addition, the TD-204/U provides for up to 39 TD-206/G's in the transmission cable, and contains an order-wire facility.

b. Technical Characteristics.

Channel capacity ..... 12, 24, or 48  
 Input voltage ..... 109 to 121 volts, 47 to 63 Hz.  
 Power consumption ..... 62 watts maximum  
     Pcm input or output signal:  
     Impedance ..... 91 ohms  
     Amplitude ..... Pulses go positive to approximately 0 volt from a baseline of approximately -2 volts.  
 Pulse type ..... Binary (full width)  
     Pulse rate and interval:  
     12-channel operation... 576 kHz; 1.736 psec  
     24-channel operation... 1,152 kHz; 868 nsec  
     48-channel operation... 2,304 kHz; 434 nsec  
     Timing input or output signal:  
     Impedance ..... 91 ohms  
     Amplitude ..... Positive going pulses, 2 volts amplitude.  
     Pulse type ..... Sharp spike  
     Pulse width ..... 150 nsec  
     Repetition rate ..... 576 kHz  
 Repetition rate:  
     12-or24-channel operation 576 kHz  
     48-channel operation... 2,304 kHz  
     Pulse width ..... 150 nsec (max.)  
 Cable input or output signal:  
     Impedance ..... 62 ohms  
     Amplitude:  
         To-cable signal .... Leading edge of pulses swing 2 volts from zero to peak.  
         From-cable signal 30 mV pp nominal  
     Pulse type ..... Binary dipulse  
     Bit rate ..... 2,304 kHz  
     Pulse width ..... 180 to 230 nsec  
 Compatible cable ..... CX-4245/G or CX-11230/G

**3-2. Multiplexer TD-7654/G**

a *Use.* The TD-754/G provides the capability for transmission of pulse-code-modulation (pcm) pulses through cable transmission systems. Pcm pulses from Multiplexer TD-660/G, or similar equipment, are applied to the TD-754/G. In the TD-754/G, the pcm pulses are encoded into another pcm format and transmitted at a 2304-kHz rate through a cable link to another TD-754/G or TD-204/U. The TD-754/G, or TD- 204/U at the opposite end of the cable link decodes the pcm pulses into their original pcm format and applies them to a TD-660/G or similar equipment. The TD-754/G also provides cable current to power Restorers, Pulse Form TD- 206/G installed in the cable link. Order wire facilities that operate over the cable link are also contained in the TD-754/G to provide a phone link between terminals.

b. System Information.

(1) Two TD-754/G's can be operated on a cable link that extends to 40 miles. The pcm pulses from a TD-754/G are transmitted through Cable Assembly, Special Purpose, Electrical CX-11230/G or CX-4245/G that connects between each TD-206/G spaced between each mile of cable.

c. Technical Characteristics.

Number of audio channels .... 6 or 12  
 Compatible radio set ..... AN/GRC-103  
 Compatible cable ..... CX-11230/G or CX24/G.  
     Order wire:  
     Facility ..... Baseband channel independent of pcm traffic.  
     Frequency response ..... 300 to 1,700 Hz  
     Signaling frequency ..... 1,600 Hz  
     Transmit level ..... 9 volts rms min at 880 ohms  
         (at cable transmit amplifier output).  
     Receive level ..... Adjustable 150 mV rms to 16 volts rms across 880 ohms (at cable receive amplifier input).

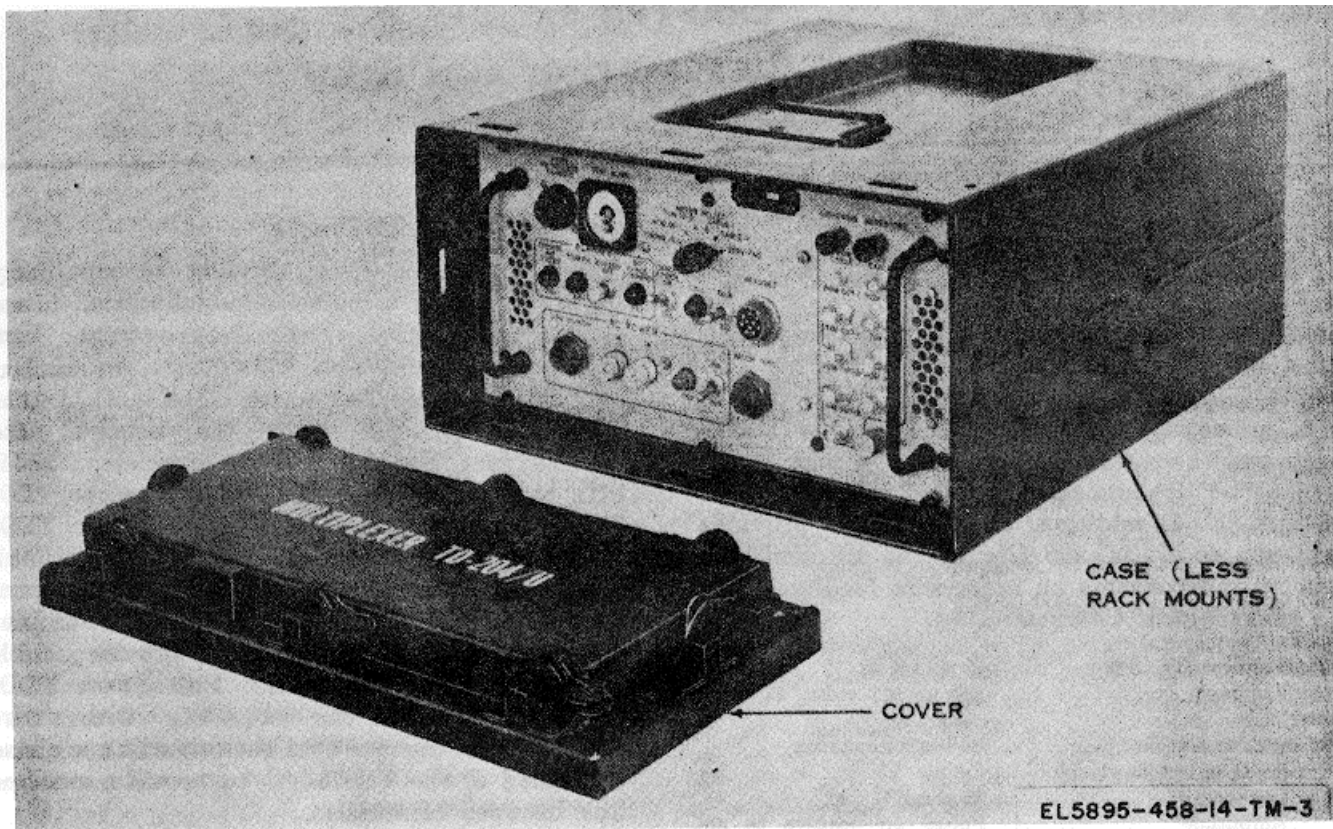

Figure 3-1. Multiplexer TD-204/U.

Cable input/output data:

Type of modulation .....PCM (Dipulse)  
 Type of multiplexing .....Time-division-multiplex  
 Cable input/output  
     impedance .....91 ohms  
 Pulse width .....200 f: 30 nsec  
 Pulse frequency .....2304-kHz bit rate  
 Band width. ....1-MHz bandpass

External equipment input/output data:

Pulse amplitude .....2 volts-rising to a peak

amplitude of 0 volt from a base voltage of -2 volts.

Pulse bit rate and pulse interval:

6-channel operation .....288 kHz; 3.472 usec  
 12-channel operation .....576 kHz; 1.736 usec  
 Power requirement ..... 109 to 121 volts ac, single phase, 47 to 420 Hz.  
 Power consumption .....35 watts  
 Power output .....24 watts (maximum)  
 Power output regulated current to cable .....38±1.1 ma

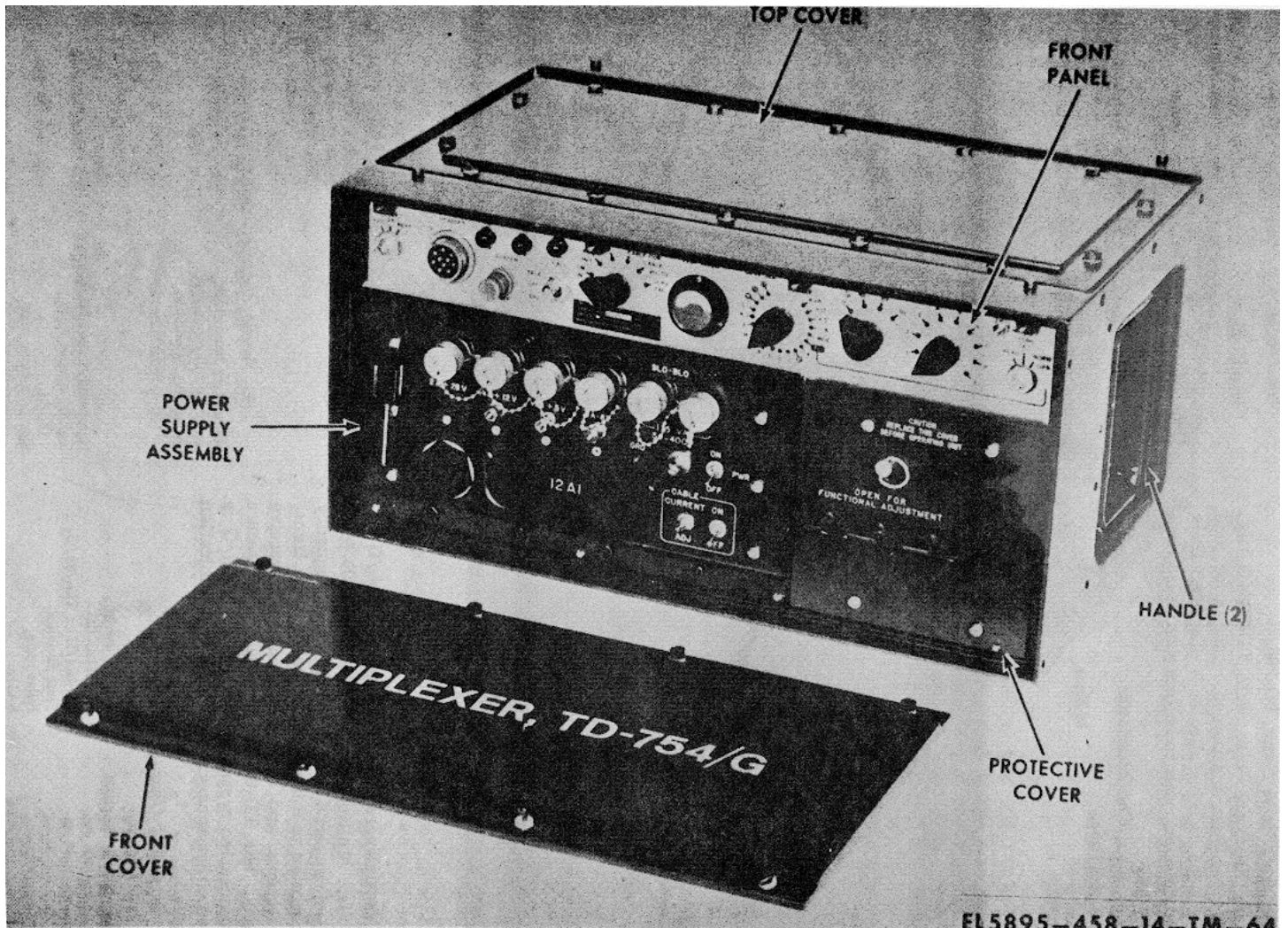

EL5895-458-14-TM-64

Figure 3-2. Multiplexer TD-754/G.  
3-3

**3-3 Restorer, Pulse Form TD-206/G**

a. Use. Restorer, Pulse Form TD-206/G (fig. 3-3) is a two-way unattended' repeater for pcm cable systems. It is installed at 1-mile intervals in the transmission cable to restore pcm pulse form and timing.

b. Technical Characteristics.

Input or output signal:

Impedance ..... 62 ohms

Amplitude:

Input signal..... 30 mV pp max, 10 mV min

Output signal..... Leading edges of puls swing 2 volts from zero peak.

Pulse type..... Binary dipulse

Pulse rate..... 2,304 kHz

Pulse width..... 205 nsec

Power requirements..... 38-mA constant curre] supply (from TD-204/U TD-754/G at either end)

Operating temperature.. +126 F to -60° F

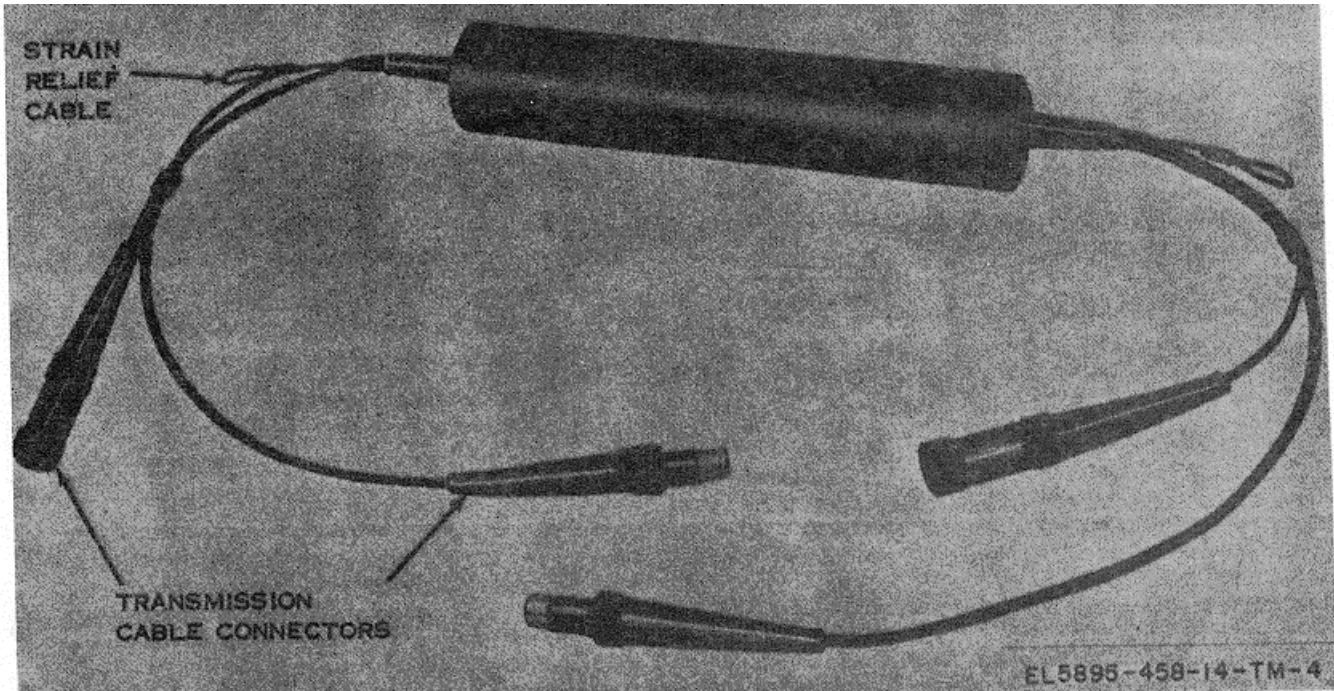

Figure 3-3. Restorer, Pulse Form TD-206/G.

**3-4. Multiplexers TD-660/G or TD-660A/G**

a. Use. Multiplexers TD-660/G or TD-660A (fig. 3-4) convert 6 or 12 four-wire voice-frequency (vf) channels to a tdm-pcm signal in their transmit sections and vice versa in their receive sections. The TD-660/G is used in nonsecure communication systems, and the TD-660A/G is used in either nonsecure or secure communication systems.

b. Technical Characteristics.

(1) General.

Number of audio channels .....6 or 12; 4-wire  
 Compatible radio set .....AN/GRC-103  
 Compatible cable set.....TD-204/U or TD-74/G  
 Type of multiplexing.....Time division  
 Type of modulation.....Pulse code  
 Channel sampling rate .....8 kHz  
 Number of pcm digits per channel sample ..... 6

Addressing .....2- or 4-kHz binary pattern with a locking time of less than 1/4 second (uses the last digit position of the last channel in each frame).

**(2) Audio channel characteristics.**

Modulating bandwidth .....300 to 3,500 Hz  
 Input for full modulation.....-4 dBm  
 Output for full modulation (nominal).....-4 dBm (4-wire);+1 dBm (2-wire) (output is adjustable from --6 to + 5 dBm).  
 Input and output impedance....600 ohms balanced  
 Signal-to-noise ratio (F1A) .....More than 55 dB  
 Signal-to-noise plus crosstalk ratio .....More than 53 dB  
 Signal-to-total distortion ratio .....More than 30 dB



**(3) Pcm input-output signal characteristics.**

Impedance.....91 ohms  
 Pulse amplitude.....Pulses rise to approximately  
 0 volt from a baseline of  
 approximately -2 volts.  
 Pulse rate:  
 6 channels.....288 kHz  
 12 channels.....576 kHz  
 Pulse width, full interval:  
 6 channels.....3.472 sec  
 12 channels.....1.736 sec  
 Channel interval:  
 6 channels.....20.8 sec (48 kHz)  
 12 channels.....10.4 sec (96 kHz)  
 Frame interval .....125 sec (8 kHz)

**(4) Timing input-output signal characteristics.**

Impedance.....91 ohms  
 Pulse amplitude.....Pulse rise to approximately  
 0 volt from a baseline of  
 ..... approximately --2 volts.

Pulse width.....100 nsec (approx.)

Repetition rate:  
 12 CH TIM OUT.....576 kHz  
 6 CH TIM OUT.....288 kHz  
 (5) Power supply.

Primary power input:  
 Voltage.....115 volts ac±5 percent  
 Frequency.....50 to 400 Hz  
 Power.....4 watts

Voltage (volts)	Maximum current (amperes)	Fuses (260V)
+12	1.2	1½A
+7	.15	N/A
+4	1.9	3A
-12	.9	1½A
-6	.15	¼A
-4	.4	¼A
+24	.05	¼A
Regulation	.....3 percent	
Operating temperature range	..-20° F. to + 126° F	

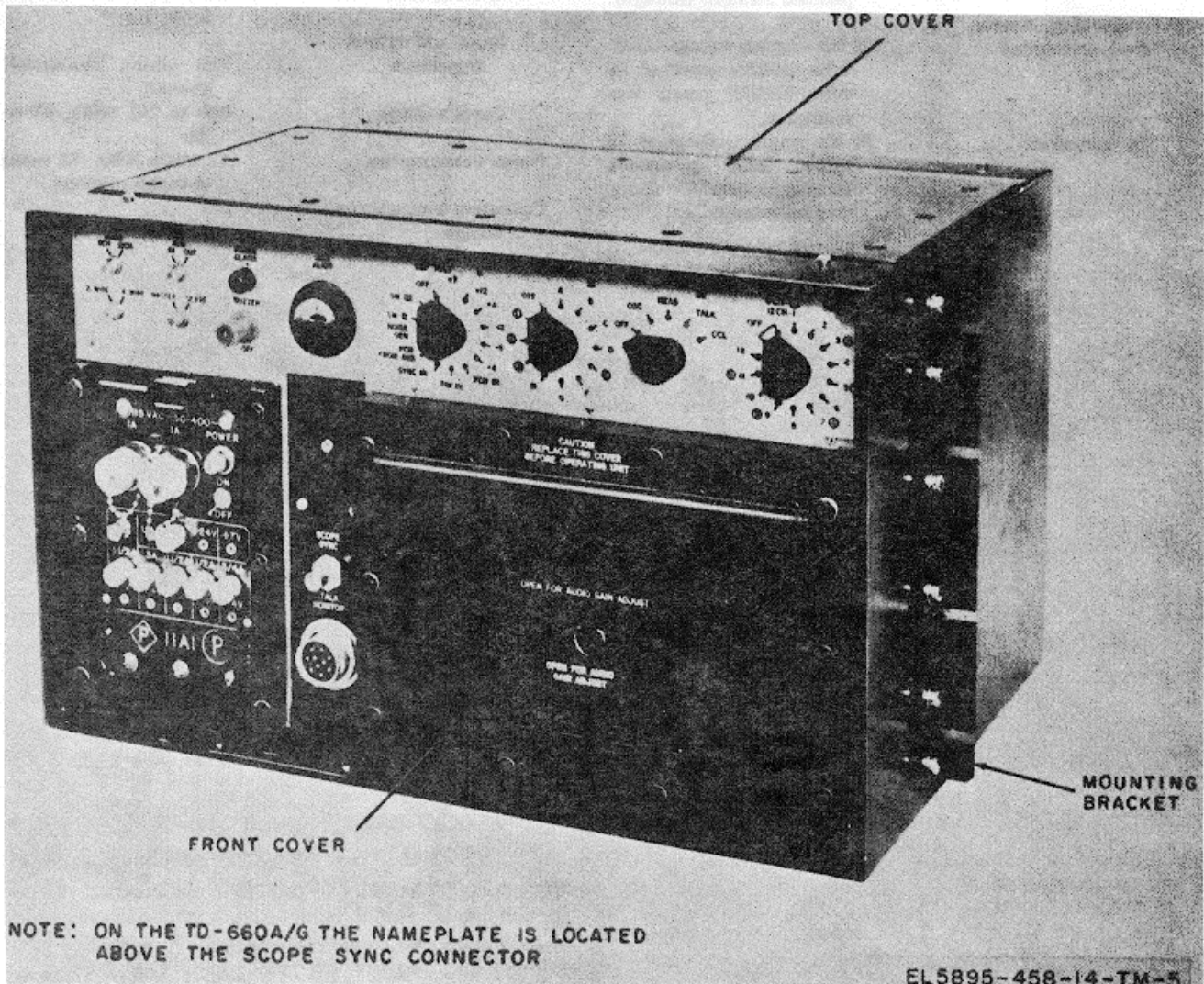

Figure 3-4. Multiplexer TD-660/G.



**3-5. Converter, Telephone Signal CV-1548/G**

a Use. Converter, Telephone Signal CV-1548/G (fig. 3-5) provides telephone signal conversion and hybrid facilities for 12 voice frequency channels. Each channel contains one-way plug supervision and ringdown signaling conversion facilities, a hybrid for converting between 2-wire and 4-wire circuits, 4-wire straight-through patching, and switching for selecting combinations of these functions.

b. *Technical Characteristics.*

No. of channels ..... 12  
 Operating modes (selected independently in each channel). . . 20 Hz signaling 2-wire; plug supervision signaling, 2-wire (one-way from originator to terminator); no signaling, 2-wire (hybrid only in use); no signaling; 4-wire (channel patched straight through).

20 Hz signaling, 2-wire:  
 From subscriber ..... 20 Hz ringing voltage at 21 volts (18A3A panel) or 16 volts (18A3B panel) rms minimum.  
 To subscriber..... 20 Hz ringing voltage at 75 volts rms minimum (across four lines simultaneously).

Plug supervision signaling (2 wire) modes:  
 Originate (OR) Switchboard trunk opens or closes T (tip) and R (ring) lead circuit in 18A3A or 18A3B panel.  
 Terminate (TE)..... 18A3A or 18A3B panel opens or closes T (tip) and R (ring) lead circuit in switchboard trunk.

Plug supervision:  
 One way .....18A3A and 18A3B  
 Two way ..... 18A4  
 Multiplex terminal inputs and outputs, 4-wire (all signaling modes):  
 From multiplex terminal No tone or 1,600 Hz inband tone between --25 and 0 dBm.  
 To multiplex terminal No tone or 1,600 Hz inband tone at -15 dBm

(adjustable + 5 dB).  
 Channel characteristics (2-wire):  
 Insertion loss .....4.5 dB maximum (250 to 3,500 Hz)  
 Input and output impedance .....600 ohms (balanced to ground)  
 Input voltage ..... 109 to 121 volts, 47 to 420 Hz  
 Power consumption 17 watts (idle), 60 watts (all channels ringing).  
 Operating temperature:  
 Range .....+1250 F. to -26 F.

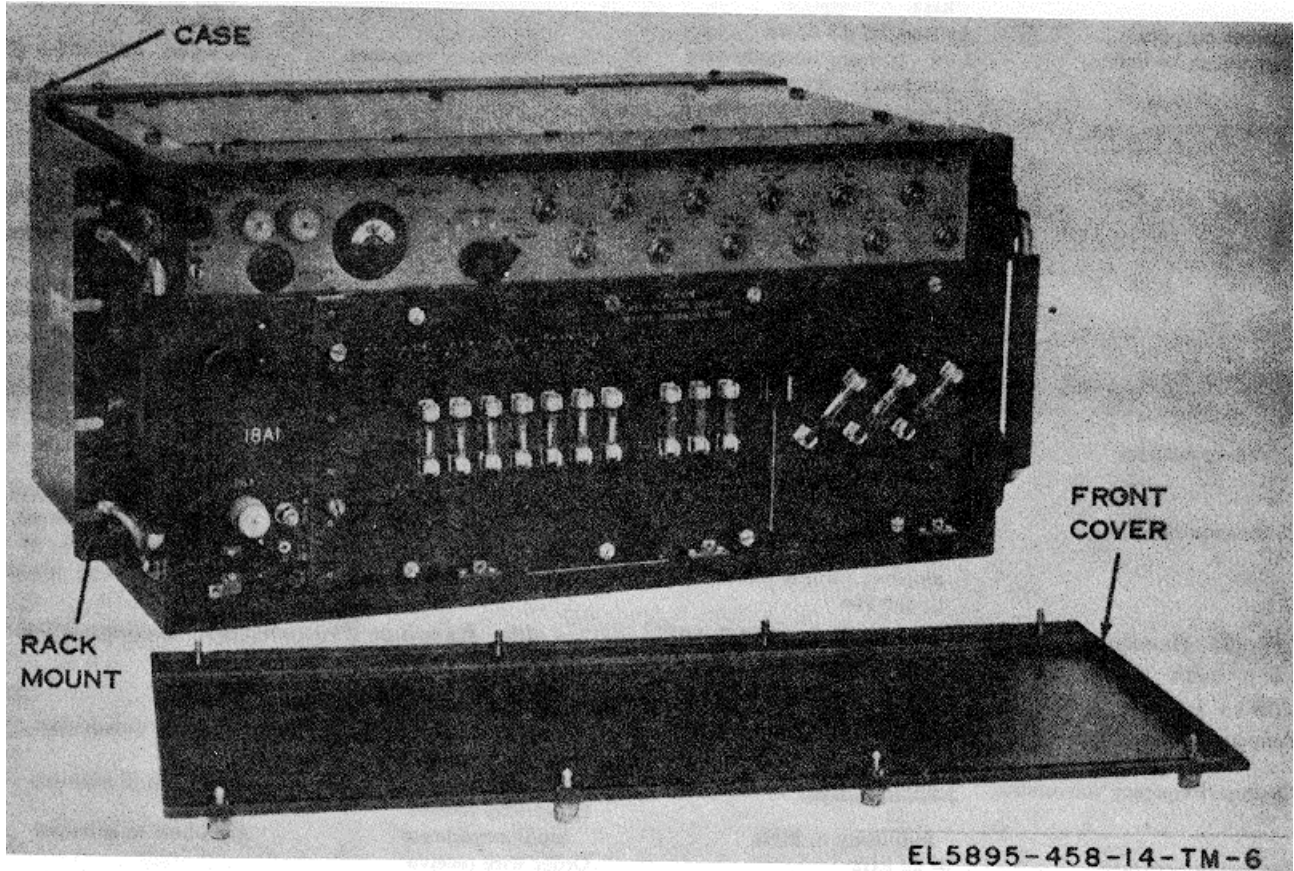

Figure 3-5. Converter, Telephone Signal CV-1548/G.

**3-6. Radio Set AN/GRC-103(V)**

a. Use . Radio Set AN/GRC-103(V)1 (fig. 3-6) is a transportable radio set that provides facilities for multichannel radio transmissions and reception of pulse-code modulation (pcm) signals. With appropriate plug-in transmitting and receiving units, the radio set operates in the frequency range of 220 to 1,000 MHz in any one of 1,561 (RF) channels selectable in 0.5 MHz increments. The radio set will accommodate up to 24 telephone channels when used with the appropriate pcm multiplex equipment. Configurations of Radio Set AN/GRC-103 (V) are the AN/GRC-103 (V)1 (Band I), the AN/GRC- 103(V)2 (Band II), and AN/GRC-103(V)3 (Band III). Operating with its own antenna system Radio Set AN/GRC-103 (V)(\*) provides good performance over line-of-sight paths in excess of 50 miles (80.45 kilometers) and has sufficient reserve power to give satisfactory operation over obstructed paths. An order wire circuit, which includes facilities that connect all stations of a system on a party line basis, is provided for the use of operating and maintenance personnel.

b. *Technical Characteristics.*

(1) Transmitter, Radio T-983 (P)/ GRC- 103( V) with Amplifier-Frequency Multiplier AM-4320/GRC-103 (V).

Frequency range:

- Band I 220.0 MHz to 404.5 MHz  
(channels 40-409).
- Band II ..... 394.5 to 705.0 MHz  
(channels 389-1,010).
- Band III ..... 69.0 to 1000 MHz  
(channels 990-1,600).

Channel/Frequency conversion  $\frac{\text{Channel No.} + 200}{2} =$   
..... frequency in MHz

Frequency accuracy.....  $\neq 20$  kHz

Output power:

- Band I ..... 25 watts minimum
- Band II ..... 15watts minimum
- Band III ..... 15 watts minimum

Output impedance..... 50 ohms, nominal, unbalanced

Modulation..... Frequency Modulation (FM)

Frequency deviation.....  $\neq 300$  kHz maximum

Output vswr ..... 1.6:1 maximum

Deviation sensitivity..... 00 kHz to 400 kHz per volt adjustable.

Input impedance, video ..... 91 ohms unbalanced

Input impedance, order

wire ..... 600 ohms unbalanced

Frequency response..... Gaussian;  $-2.9 \pm 0.7$  decibels (dB) at 500 kHz;

-11.0 ± 3.0 dB at 960 kHz.  
 Spurious outputs.....At least 80 dB down  
 Alarms (can be muted).....Low power (transmitter output); synchronize (sync) (synthesizer automatic frequency control (afc) lock); overheat (transmitter output tube).  
 Metering.....Power supply voltages; reflected power; oscillator and multiplier output levels; power output; modulation levels.  
 Order wire input.....-10 decibels (referred to 1 milliwatt in 600 ohms (dBm))  
 Auxiliary outputs .....28 volts direct current (dc) regulated; 26 volts dc, unregulated.  
 Power requirements .....115 volts alternating current (ac) ± 5%, 300 volt-amperes, single-phase, 47 to 420 Hz.  
 (2) Receiver, Radio R-1329 (I/GRC-103 (V) with Amplifier-Converter AM-4316/GRC-103(V).  
 Frequency range .....Same as T-983(P)/GRC-103(V)  
 Channel/frequency conversion Channel No. + 200=  
 2  
 frequency in MHz  
 Frequency accuracy ..... ± 20 kHz  
 Modulation .....FM  
 Input impedance .....50 ohms unbalanced  
 Input vswr at nominal received frequency ± 1MHz 2.2:1 maximum  
 Minimum transmitter-to-receiver frequency separation required .....16.5 MHz (33 channels)  
 Maximum receiver input at nominal received frequency .....-10 dBm  
 Receiver sensitivity.....-94 dBm  
 Noise figure .....9 dB nominal (11 dB maximum)  
 Demodulation sensitivity, pcm video output.....0.125 volts/100 kHz  
 Output impedance, regenerated 12-channel pcm video..91 ohms unbalanced  
 Output impedance, order wire 600 ohms unbalanced  
 Output impedance, timing pulse .....91 ohms unbalanced  
 Output level, order wire, ..... - 10 dBm from multiplex combiner  
 Intermediate frequency (IF .... -4 dBm center .....  
 IF response .....30.0 MHz ± 20 kHz Gaussian, -2.9 dB + 0.6 dB at ± 375 kHz; -19.0

dB + 3.5 dB at 960 kHz; -60 dB minimum at ± 2 MHz.  
 Video frequency response ..... Gaussian, -3.0 .5 dB at 400 kHz; -38.0 :6.0 dB at 960 kHz.  
 Pcm regenerator frequency ..... 676 kHz 0.1.%  
 Regenerated pcm output. .... 2-volt, negative peak  
 Timing pulse output level ..... 2-volt, positive peak  
 Alarms (can be muted)..... RF low signal; RF high signal; sync (synthesizer afc lock).  
 Metering ..... Power supply voltages; reflected power; oscillator and multiplier output levels; transmitter duplexer tuning; received signal level; output video levels; recovered order wire level.  
 Auxiliary outputs..... 12 volts dc, regulated;26 volts dc, unregulated.  
 Power requirements ..... 115 volts ac, ±5%, 70 volt- amperes single phase, 47 Hz to 420 Hz.

(3) Receiver-Transmitter, Order Wire RT-773/GRC-103 ( V).  
 Order wire transmit output impedance ..... 600 ohms unbalanced  
 Order wire transmit output level ..... -10 dBm (2 outputs)  
 Order wire receive input impedance ..... 600 ohms unbalanced  
 Order wire receive input ..... -10 dBm (2 inputs)  
 Handset type ..... Handset H-60/PT  
 Receive level at receiver handset ..... -18 dBm  
 Sidetone level at receiver handset ..... -24 dBm  
 Ringing tone frequency ..... 1,600 8 Hz  
 Ringing tone level..... -10 1 dB  
 Power requirements ..... 12 volts dc regulated; 26 volts dc unregulated.

(4) Dummy Load, Electrical DA-437/GRC-103( V).  
 Impedance ..... 50 ohms unbalanced  
 Vswr ..... 1.5:1 maximum; 220 MHz to 1,000 MHz.  
 Power ..... 50-watt maximum continuous

- KEY to fig. 3-6:  
 1 Transmitter, Radio T-983(P)/GRC-103(V)  
 2 Amplifier-Frequency Multiplier AM-4320/GRC-103(V)(Band I)  
 3 Receiver, Radio R-1329(P)/GRC-103(V)  
 4 Amplifier-Converter AM 1316/GRC-103(V)(Band I)  
 5 Receiver-Transmitter, Order Wire RT-733/GRC-103(V)

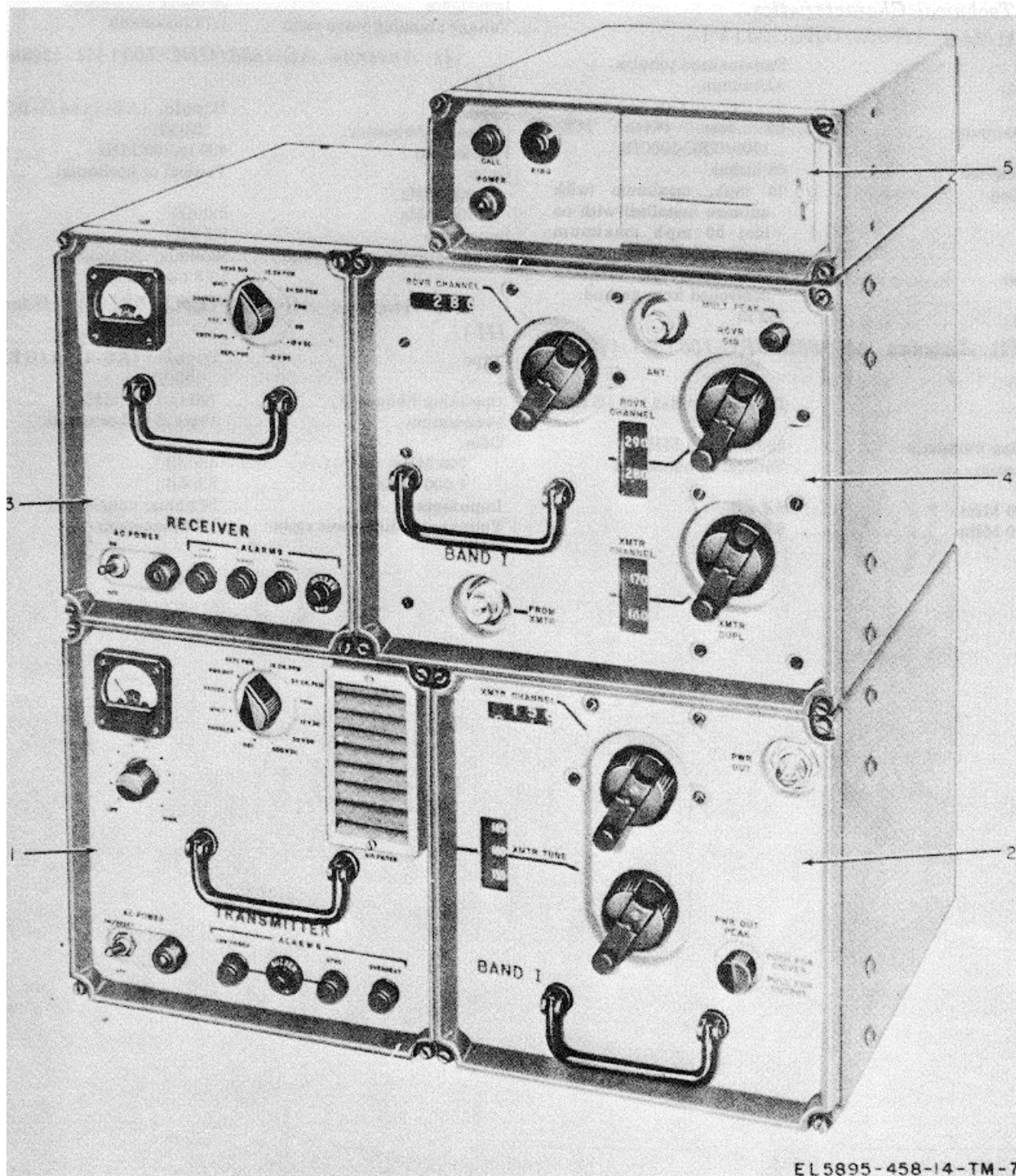

Figure 3-6. Radio Set AN/GRC-103(V)1 less antenna, mast, and minor components.

**3-7. Antenna Assembly**

a. *Use.* The antenna assembly consists of Mast AB-952/GRC-103(V) and Antenna AS-1852/GRC-103(V) (fig. 3-7) (Band I), or AS-1853/GRC-103(V) (Band II), or AS-1854/GRC-103(V) (Band III,) (fig. 3-8). Hardware is

provided for an erected antenna 35 feet high. Mast Extension Kit MK-1009/GRC-103 (V) provides additional hardware for a 50-foot erected antenna. The antenna assembly provides the transmission media between the radio link sections of the system.

**b. Technical Characteristics.**  
**(1) Mast AB-952/GRC-103 ( V).**

Type Sectionalized tubular  
 Material.....Aluminum  
 Height:  
     Maximum .....feet (with MK-  
   1009/GRC-103(V))  
     Collapsed.....63 inches  
 Wind load .....75 mph, maximum  
   (with antenna installed)  
   with no ice; 50 mph  
   maximum with ½-inch  
   radial ice.  
 Rotation .....360° azimuth rotation  
   controlled from ground.  
 Weight .....162 lb

**(2) Antenna AS-1852/GRC-103(V) (Band I).**

Type.....Dipole (AS-2193GRC-  
   103(V))  
 Operating frequency .....220.0 to 400 MHz  
 Polarization.....Vertical or horizontal  
   Gain:  
 220 MHz .....6.5 dB  
 400 MHz .....8.0 dB

Impedance .....50 ohms unbalanced  
 Voltage standing wave ratio .....1.75 maximum

**(3) Antenna AS-1853/GRC-103(V) (Band II).**

Type .....Dipole (AS-  
   2194/GRC-  
 Operating frequency.....103(V))  
 Polarization .....400 to 700 MHz  
 Gain:  
     400 .....MHz8.0dB  
     700MHz .....8.0dB  
 Impedance .....8.5 dB  
 Voltage standing wave ratio .....50 ohms, unbalanced  
   1.75 maximum

**(4) Antenna AS-1854/GRC-103(V) (Band III).**

Type .....Dipole (AS-2195GRC  
   103(V))  
 Operating frequency.....700 to 1000 MHz  
 Polarization.....Vertical or horizontal  
   Gain:  
 700 MHz .....8.5 dB  
 1,000 MHz .....9.5dB  
 Impedance .....50 ohms, unbalanced  
 Voltage standing wave ratio .....1.75 maximum

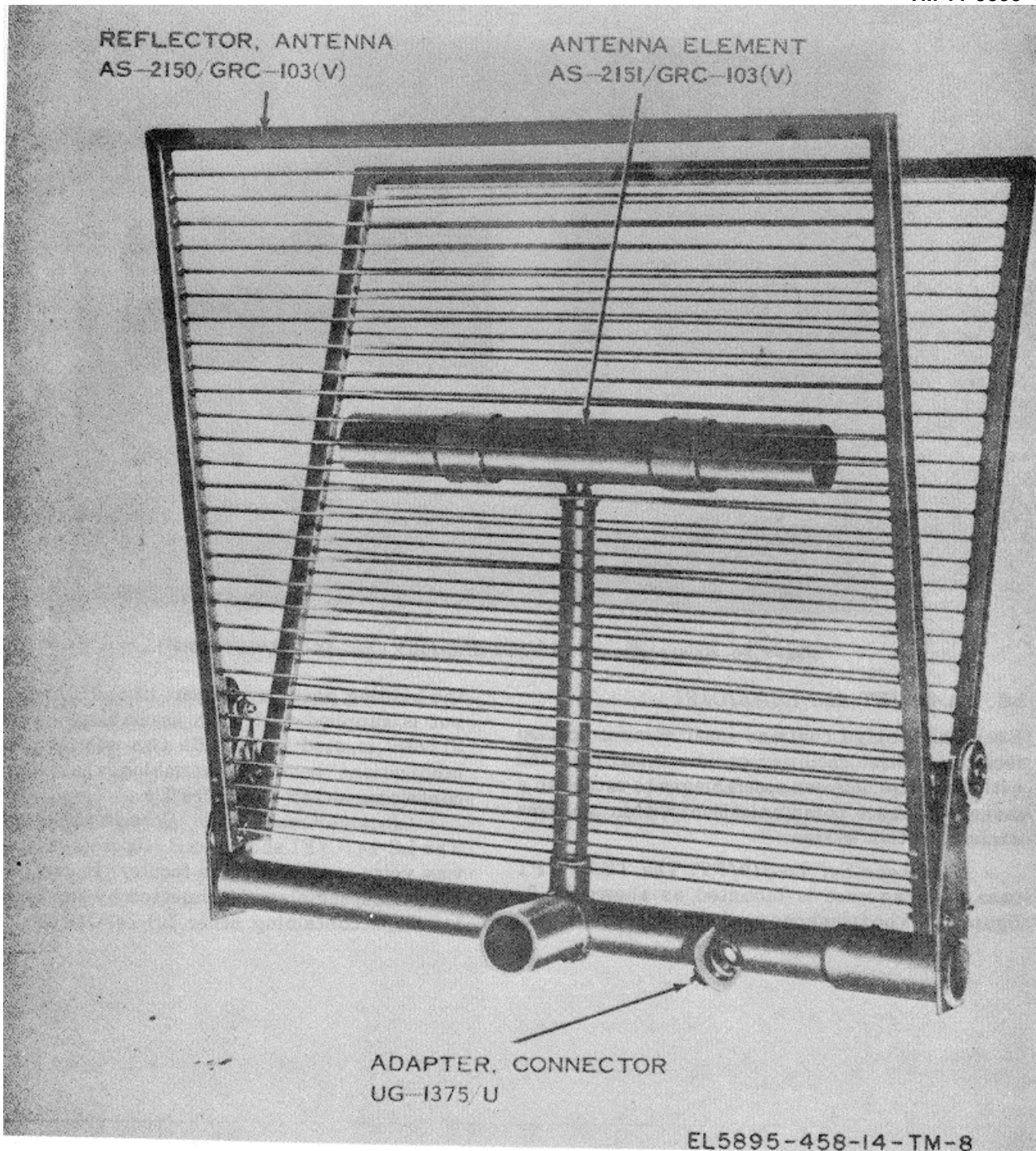

Figure 3-7. Antenna AS-1852/GRC-103(V).



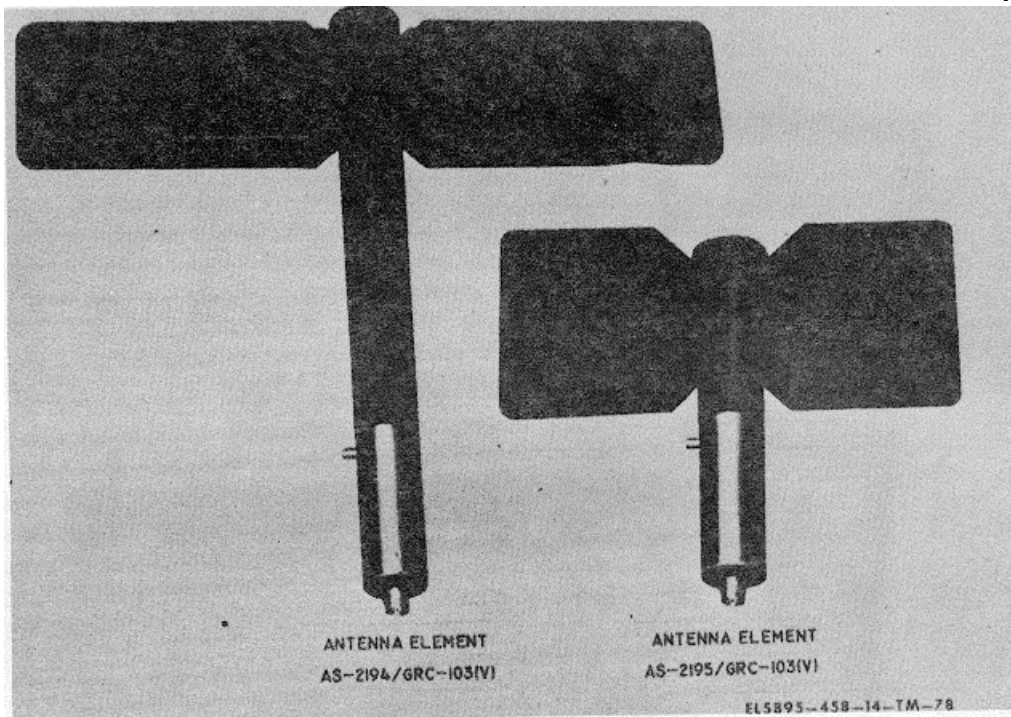

Figure 3-8. Antenna Elements AS-2194/FRC-103(V) and AS-2195/GRC-103(V).

### 3-8. TA-312/PT and LS-147C/FI

Each assemblage contains local communication facilities. These facilities can be interconnected with field wire between assemblages to establish a means of direct communication within an area communication system.

*a. Telephone Set Ta-312/PT.* The TS-312/PT (less carrying case is mounted as shown in A, figure 3-9. The telephone cord shown connected to

the binding posts is not part of the TA-312/PT, but is supplied with each assemblage. The TA-312/PT is used to provide two-way radio communications between assemblages or locations containing other TA-312/PT's.

*b. Intercommunication Station LS-147C/FI.* The LS-147C/FI shown in B, figure 3-9 is a two-way voice communication facility. It can be used between assemblages (connected by field wire) or locations containing other LS-147C/FI's.

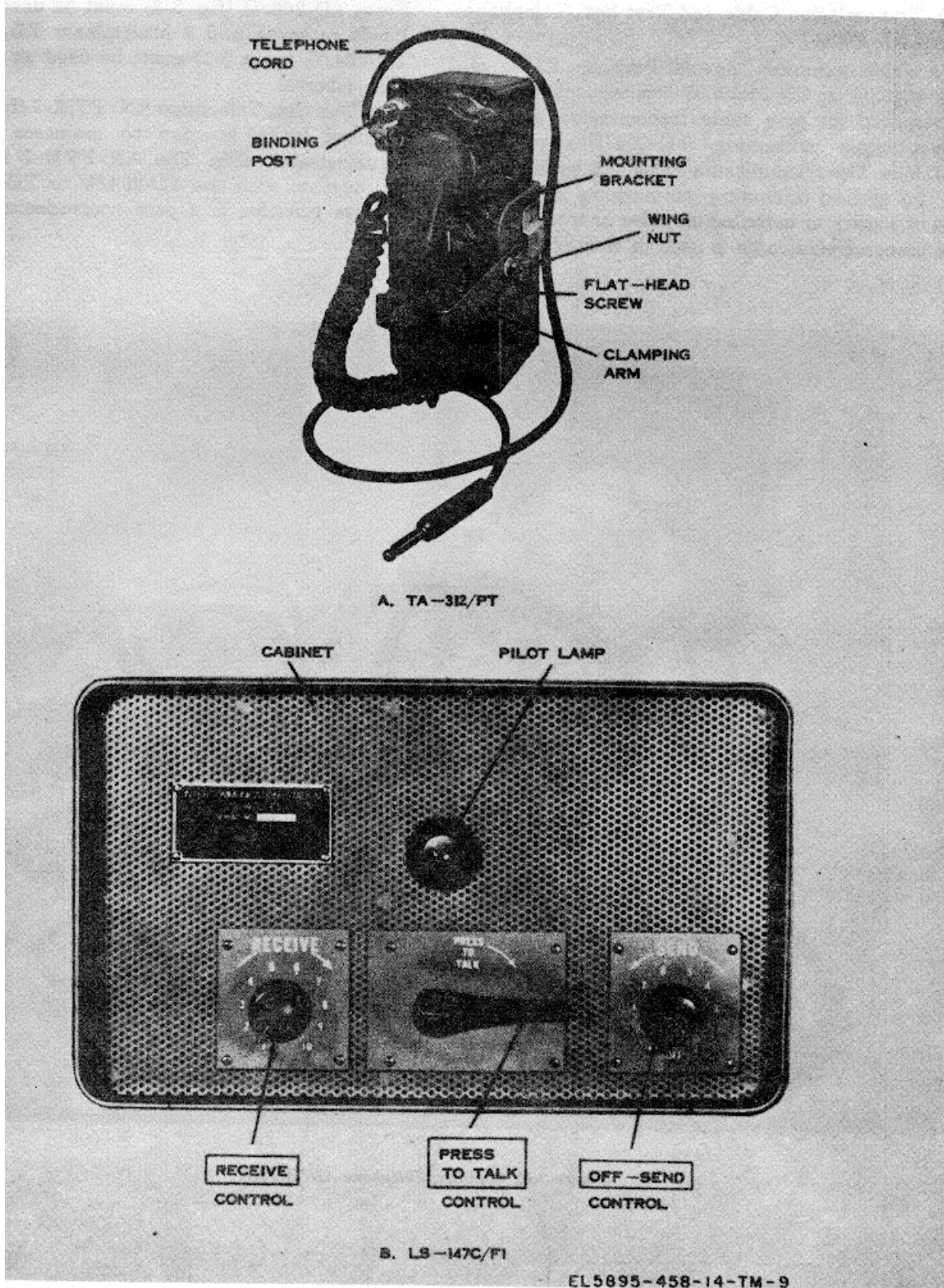

Figure 3-9. Telephone Set TA-312/PT and Intercommunication Station LS-147C/F1.



**3-9. Transmission Cable and Test Set, Telephone AN/ PTM-7**

a. Cable Assembly, Special Purpose, Electrical CX-4245/G or CX-11230/G (transmission cable) is required for pcm cable transmission between assemblages containing TD-204/U's or TD-754/G's. The transmission cable can be installed on the ground (including submerging in up to 3 feet of water), or installed on poles or trees. When the transmission cable is used, a Restorer, Pulse

Form TD-206/G (fig. 3-3) must be used at every 1-mile interval, and a Multiplexer TD-204/U or TD-754/G (para 3-1) must be used at every 40- mile interval.

b. Test Set, Telephone AN/PTM-7 (fig. 3-10) is required by a lineman to maintain the pcm transmission cable. The AN/PTM-7 is used in conjunction with the TD-204/U or TD-754/G to localize troubles in a pcm transmission cable.

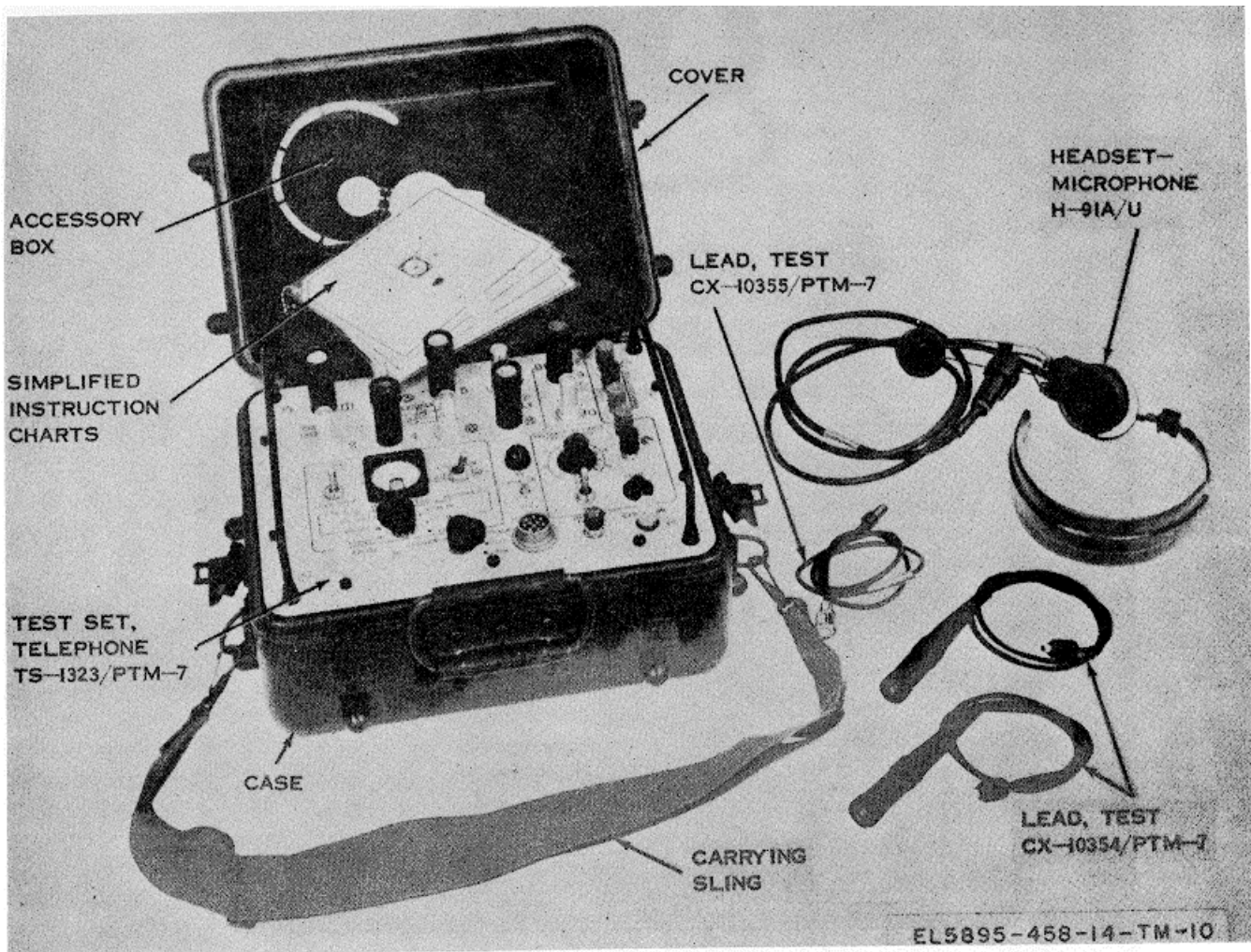

Figure 3-10. Test Set, Telephone AN/PTM-7.

CHAPTER 4

ASSEMBLAGE DESCRIPTION AND DATA

**4-1. General Characteristics**

a. The assemblages of the Low Capacity Tactical Radio Relay System are air or vehicular transportable. These assemblages utilize fully insulated and weatherproof modified lightweight field and mobile shelters of aluminum stressed skin foam-core construction, with the exception of the trailer mounted assemblages which have a tarpaulin cover which provides complete

weatherproofing. Chart 4-1 indicates the shelter or trailer type number, and the shelter or trailer facility type number (modified shelter or trailer) for each assemblage, and the type of vehicle required for transportation.

b. The dimensions of the shelter or trailer facilities are the same as the shelter and are provided in chart 4-2.

*Chart 4-1. Shelter Characteristics*

Shelter or trailer type No.	Shelter or trailer facility type No.	Assemblage type No.	Vehicle (ton)
S-260/G	S-333/TCC-65	AN/TCC-66	1 ¼
S-250/G	S-335/TRC-113	AN/TRC-113	1 ¼
S-369/GRC	V-397/MRC-116(V)	AN/MRC-115(V)	¼
S-369/GRC	V-415/MRC	AN/MRC-126 or AN/MRC-127.	¼
S-250/G	S-390/TRC-145	AN/TRC-146	1 ¼

*Chart 4-2. Shelter Dimensions*

Shelter or trailer type No.	Maximum outside dimensions (in.)		
	Length	Width	Height
S-250/G	86	79 ¼	70
S-260/G	86	79 ¼	70
S-369/GRC	108	63 ½	66

assemblages. Each assemblage has facilities for local telephone and intercommunication facilities. The interior temperature of the assemblages may be maintained relatively constant by the heaters and exhaust blowers and by the use of trailer-mounted air conditioners. Exterior views of each assemblage are shown in figure 4-1 through 4-19.

c. All components of the assemblages are mounted in equipment racks that are secured to the floor and walls of the shelter or trailer facilities. Mounting and storage facilities are provided in each assemblage for storing signal and power cable reels and spare parts. Fluorescent light fixtures are mounted on the ceilings of the assemblages to provide primary lighting. Incandescent lights provide lighting when the temperature is too low for the fluorescent lights to operate. The lighting in each assemblage may be controlled by a door interlock for blackout operations, or bypassed if blackout conditions are not required. All signal and power connections are made through entrance boxes, and routed through ductwork on the walls of the

**NOTE**

On the trailer mounted assemblages overhead swivel lights are mounted on the tarpaulin support frame for primary lighting. There are no intercommunication facilities in the assemblages. A tarpaulin cover provides complete shelter for the equipment. It is also used for weatherproofing when equipment is operational.

d. Power (115 volts, 50 to 60 Hertz, single phase) for any of the assemblages may be supplied from a central power source or from an appropriate trailer-mounted power source. The trailer-mounted power source associated with each assemblage is indicated in chart 4-3.

Chart 4-3. Power Sources

Nomenclature

Assemblage

- Generator Set, Gasoline Engine, Trailer mounted PU-628/G. AN/TCC-65
- \* Generator Set, Gasoline Engine, Trailer mounted PU-625/G. AN/TRC-113 or AN/TRC-145
- \*\* Generator Set, Gasoline Engine, 1 ½ KW, 60 Hz: SF-1.5/SIED. AN/MRC-115(V), AN/MRC-126 or AN/MRC-127.

\* The PU-625/G contains mounting and storage facilities for the power cable and antenna system required for the AN/TRC-113(V) or the AN/TRC-145

\*\* Installed on back of ¼-ton truck during transportation.

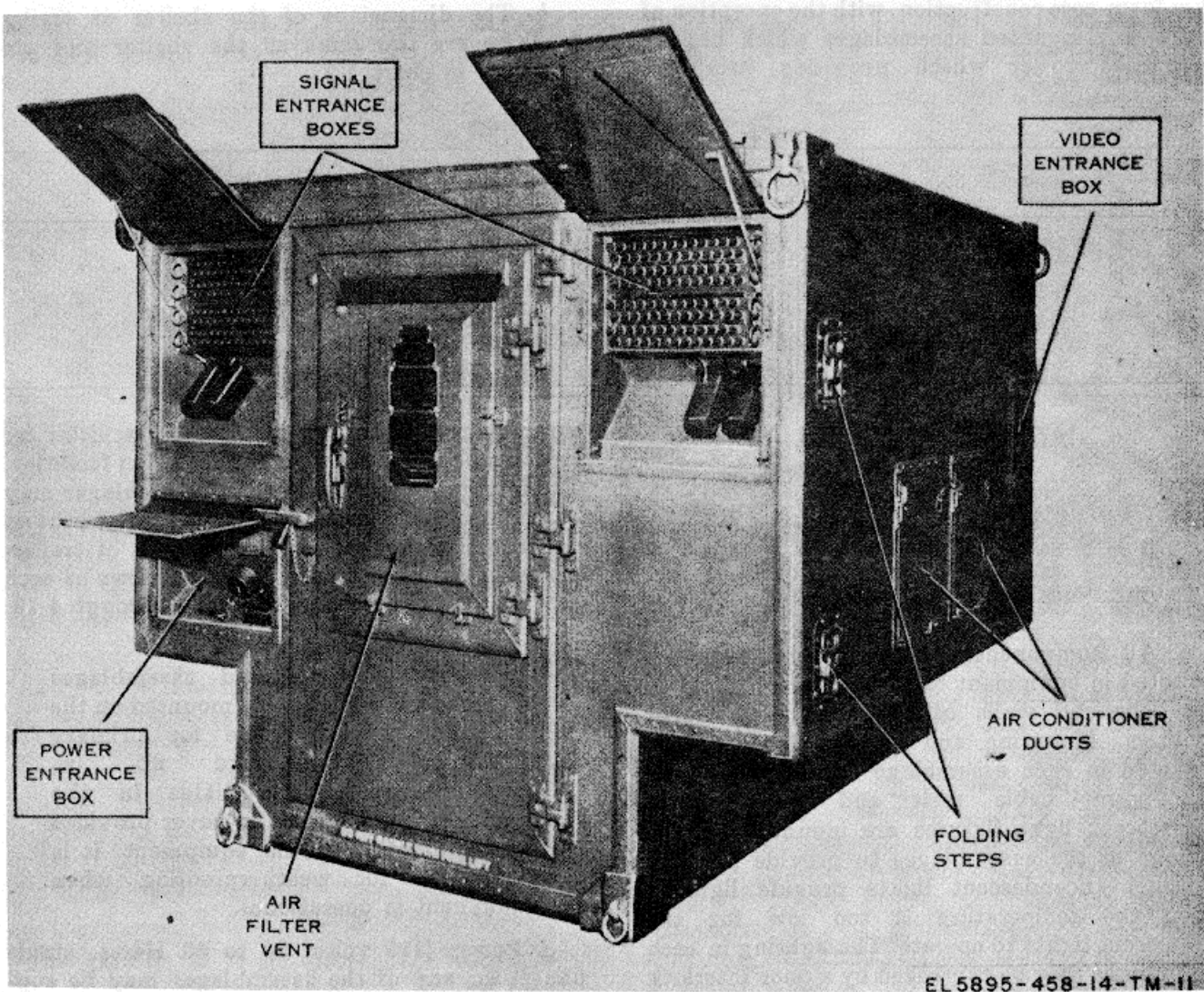

Figure 4-1. Terminal, Telephone AN/TCC-66, rear curbside view (serial No. 1 through 19).

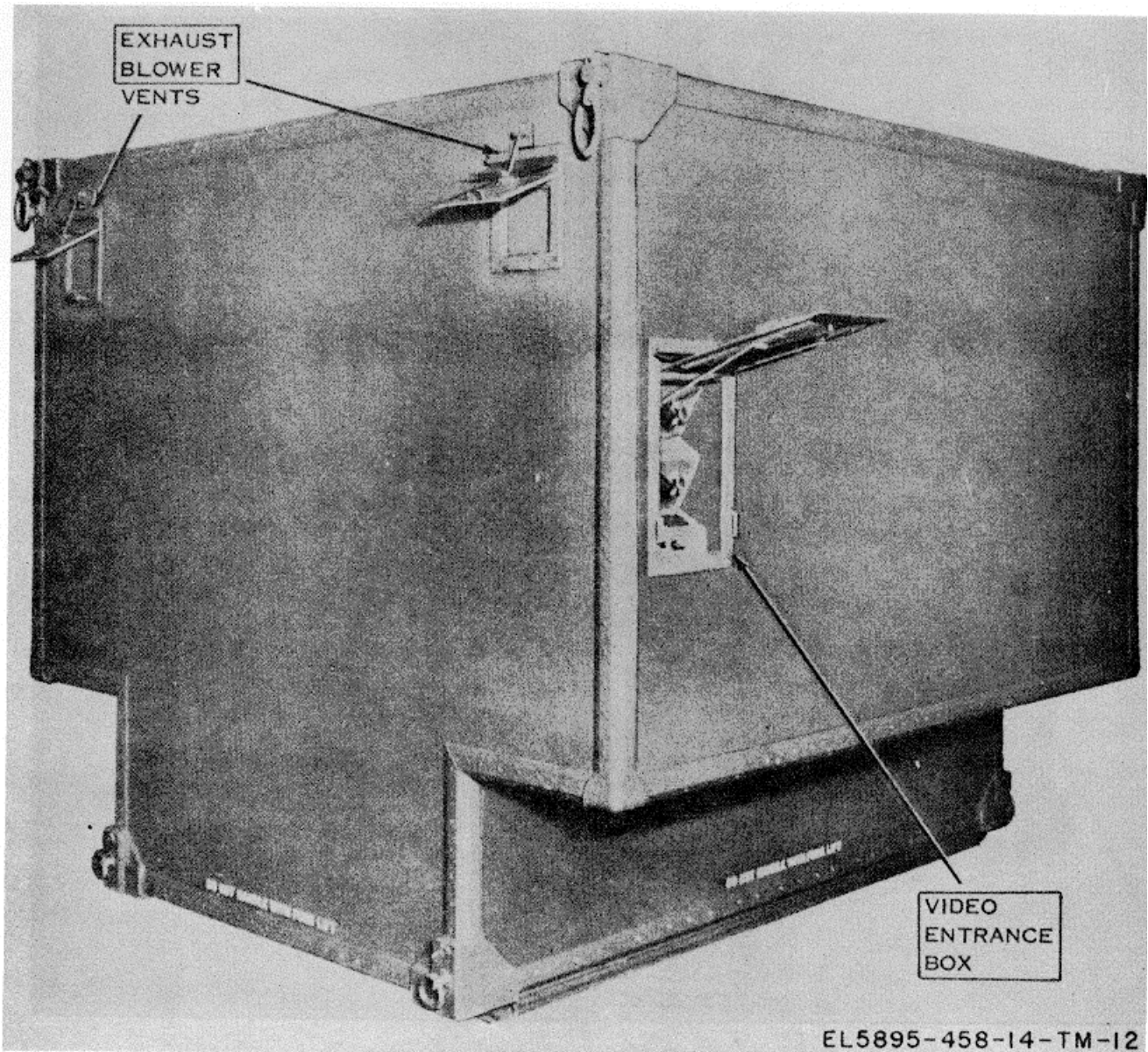

Figure 4-2. Terminal, Telephone AN/TCC-65, front roadside view (serial No. 1 through 19).



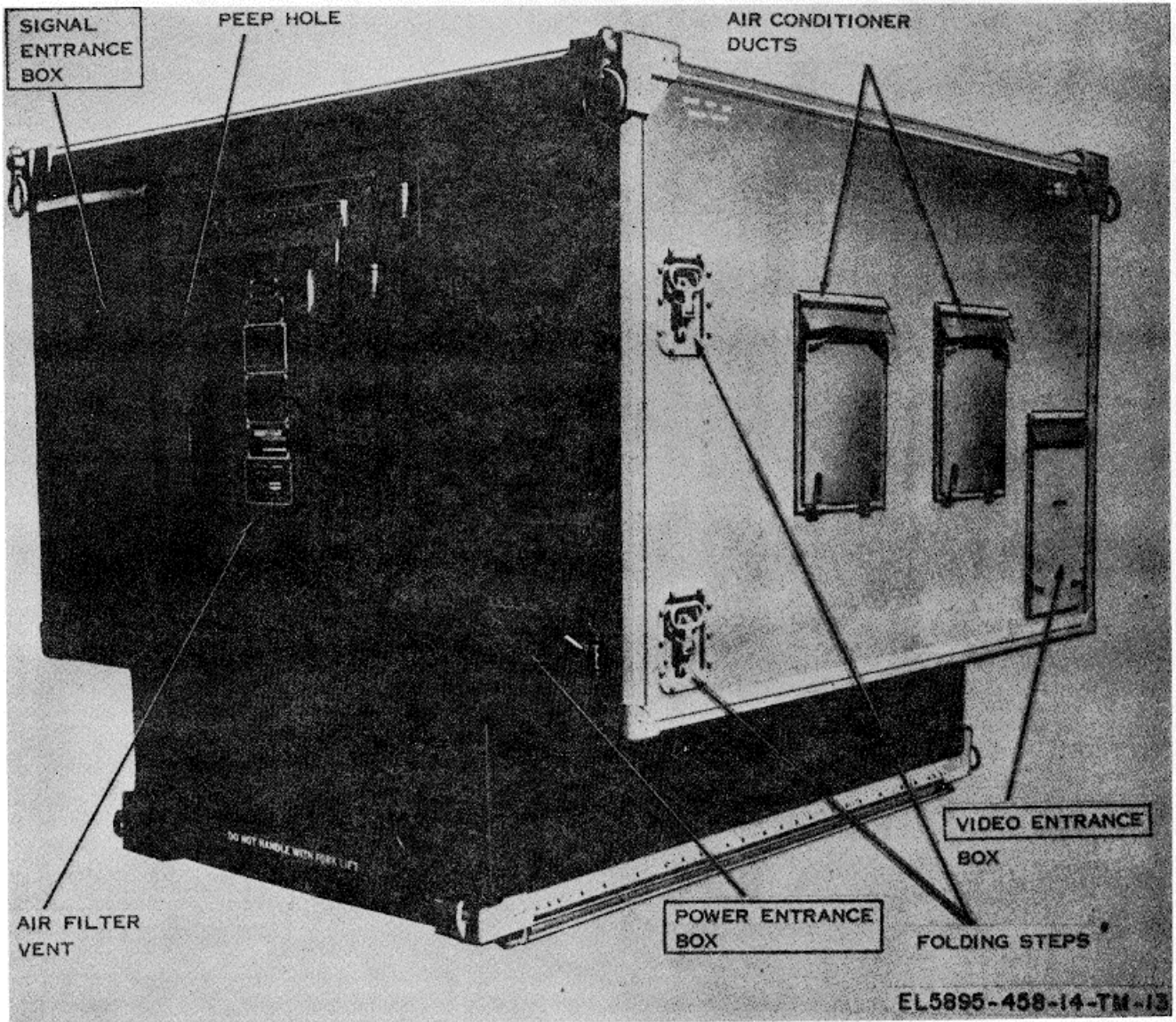

Figure 4-3. Terminal, Telephone AN/TCC-65, rear curbside view (serial No. 20 and above).

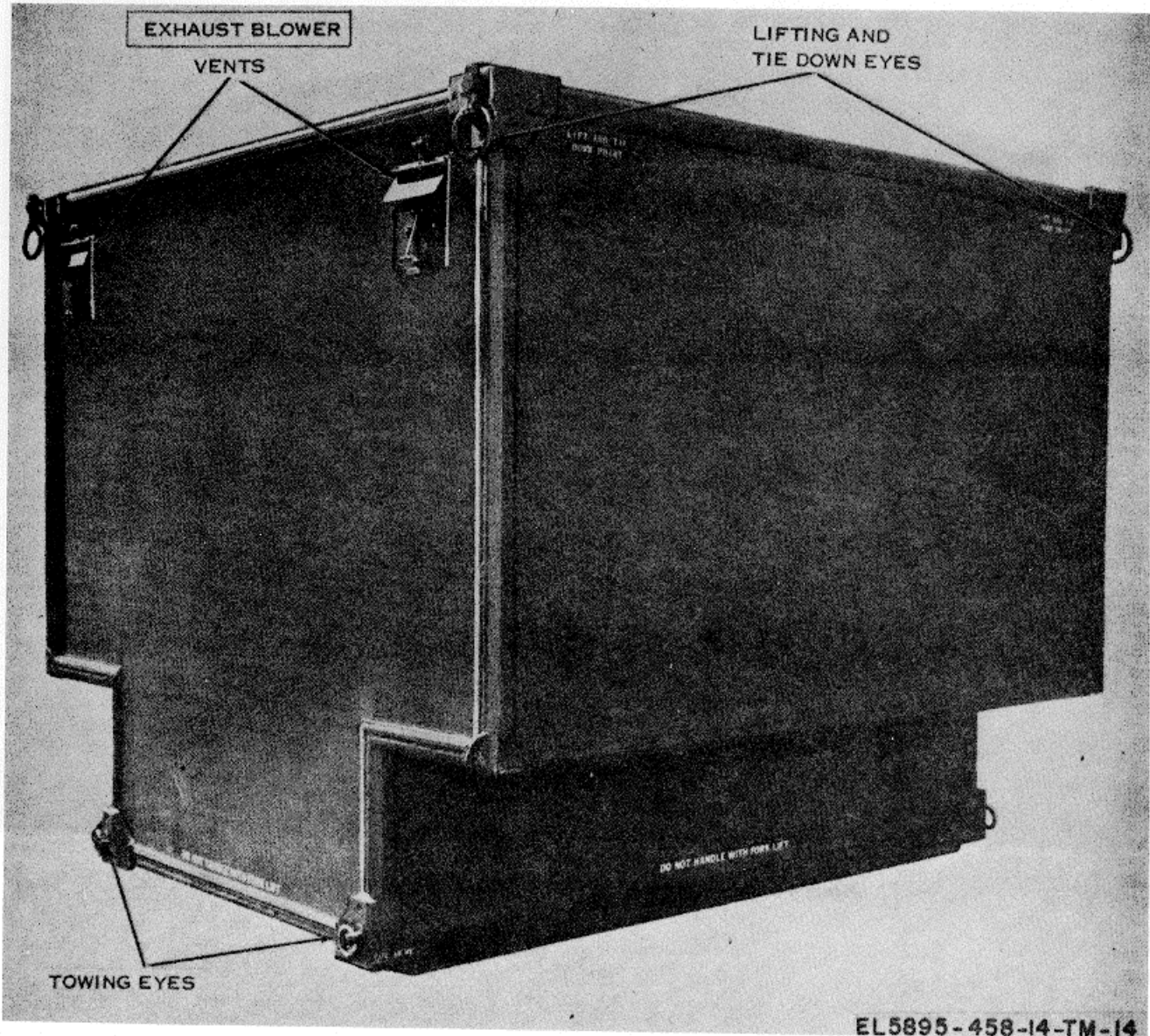

Figure 4-4. Terminal, Telephone AN/TCC-65, front roadside view (serial No. 20 and above).

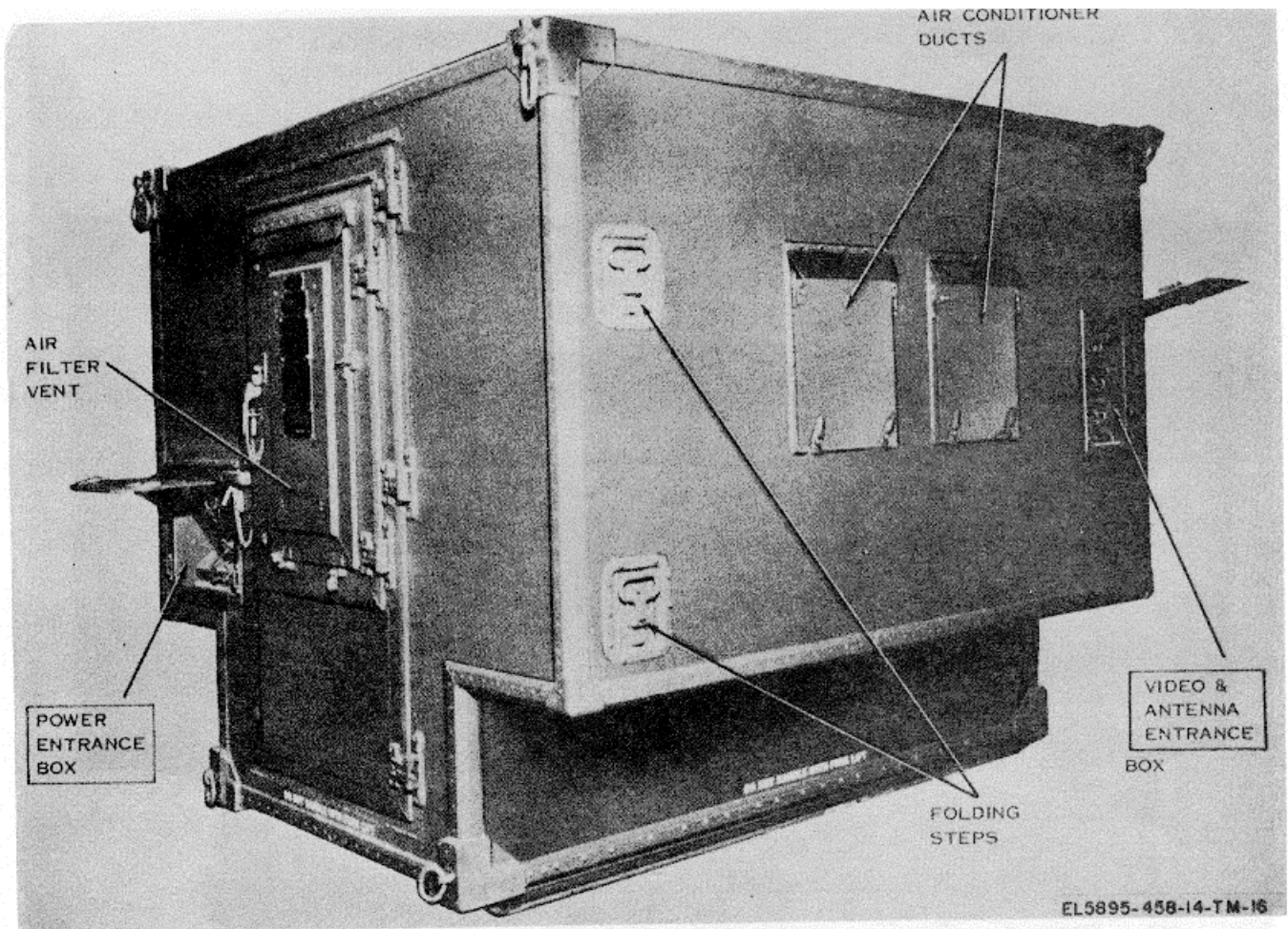

Figure 4-5. Repeater Set, Radio AN/TRC-113, rear curbside view.

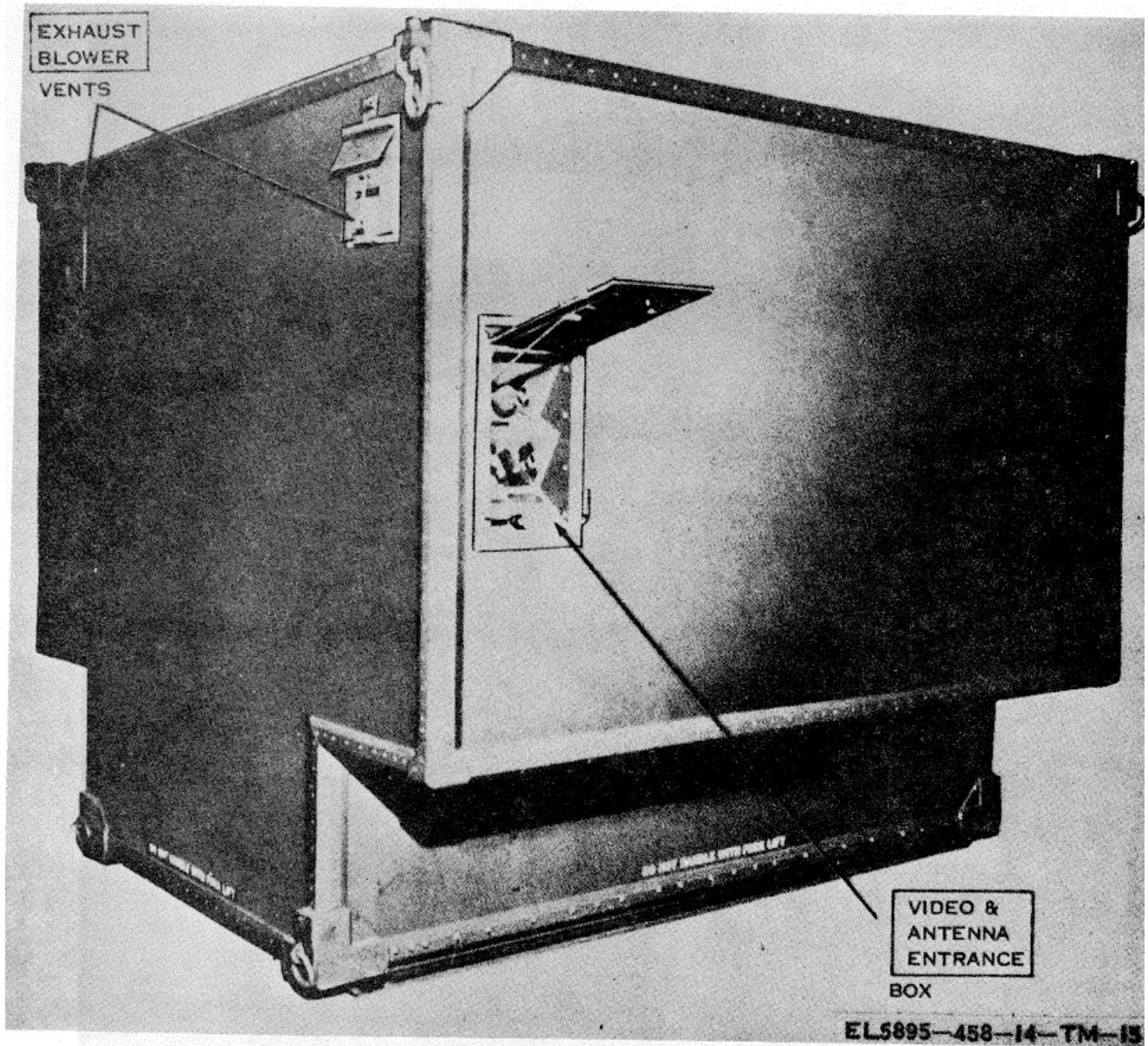

Figure 4-6. Repeater Set, front roadside view.



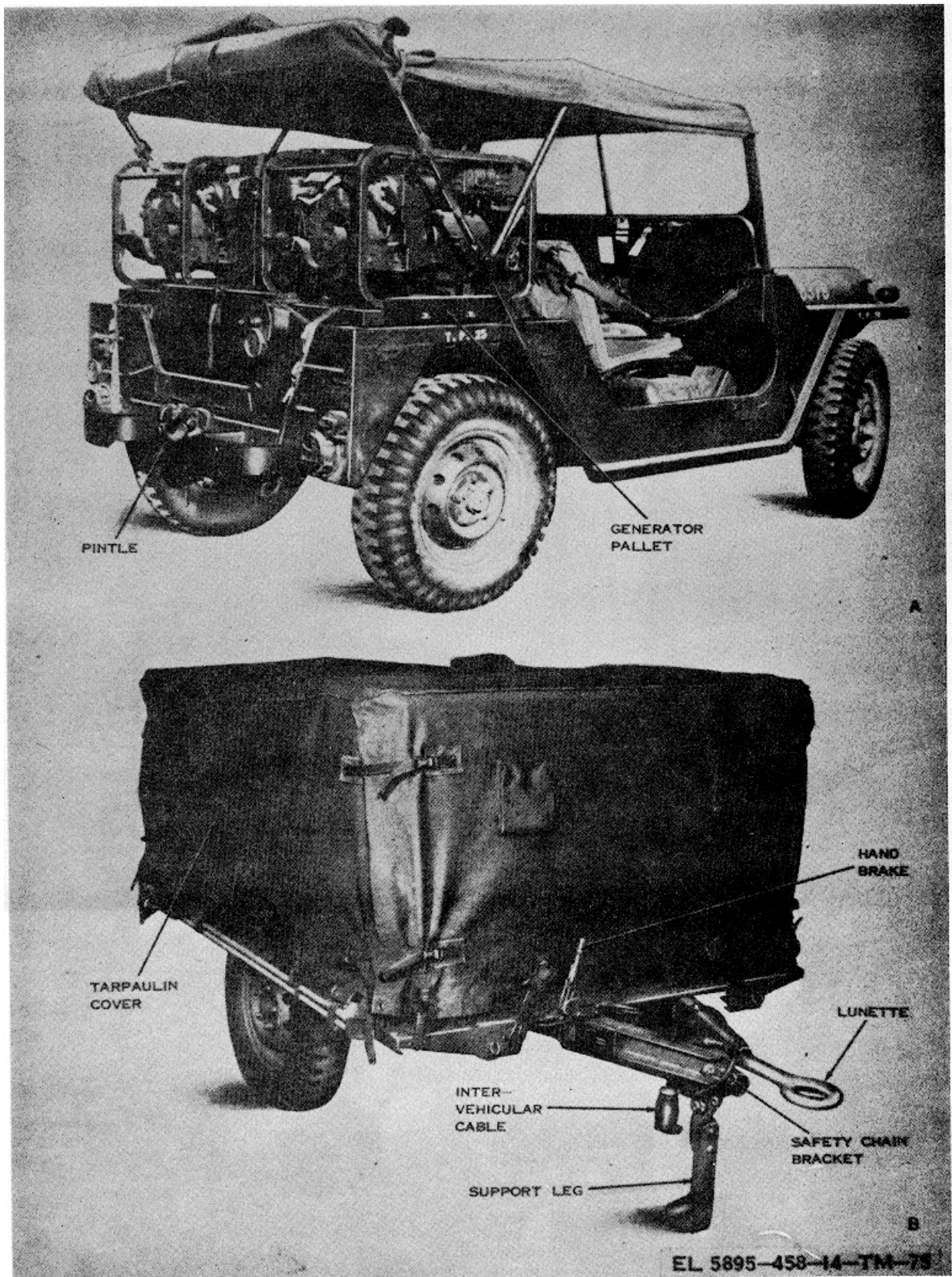

Figure 4-7. Radio Terminal Set AN/MRC-115 (V), prepared for transit.

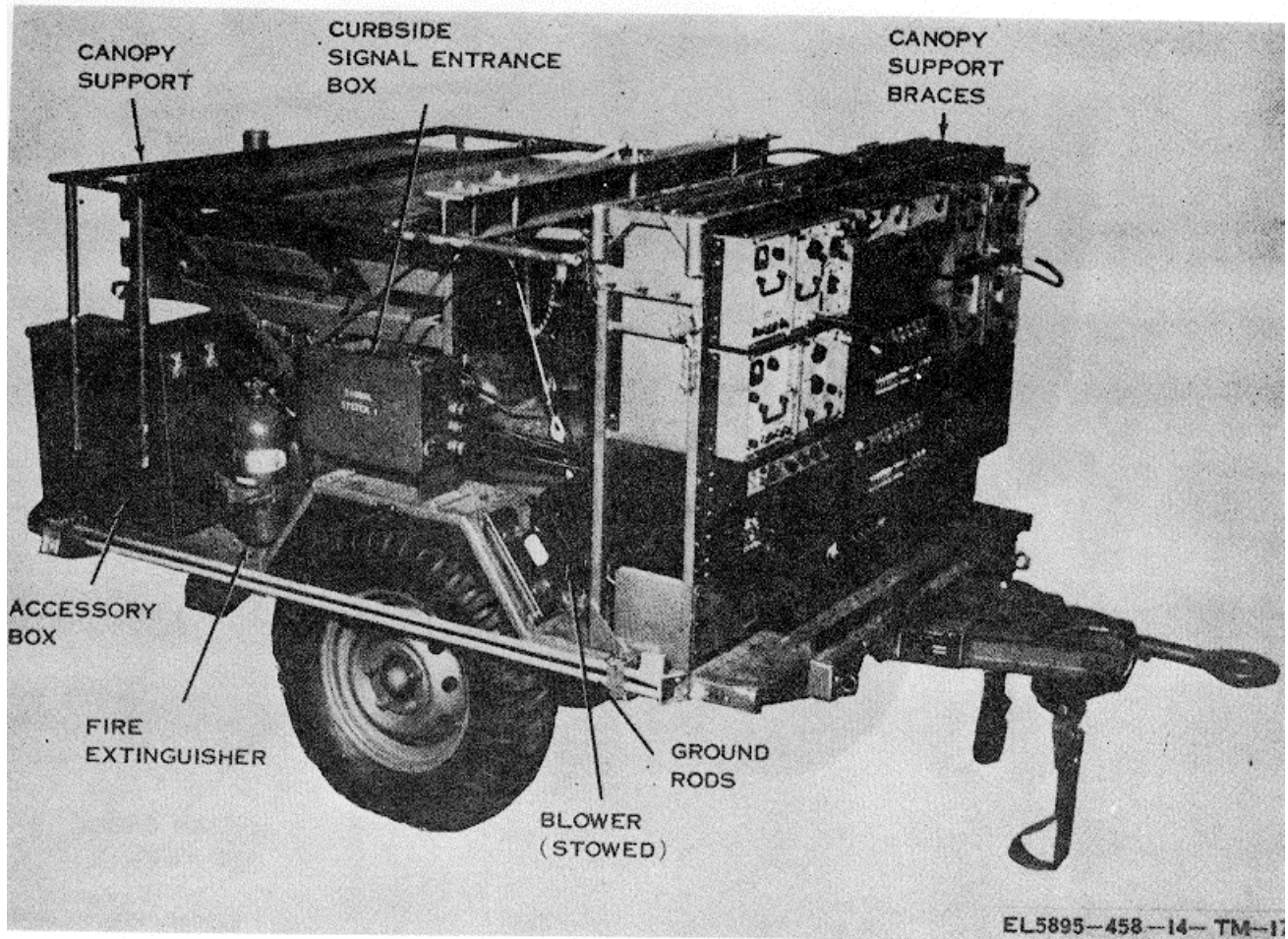

Figure 4-8. AN/MRC-115 (V) trailer, tarpaulin removed, front curbside view.

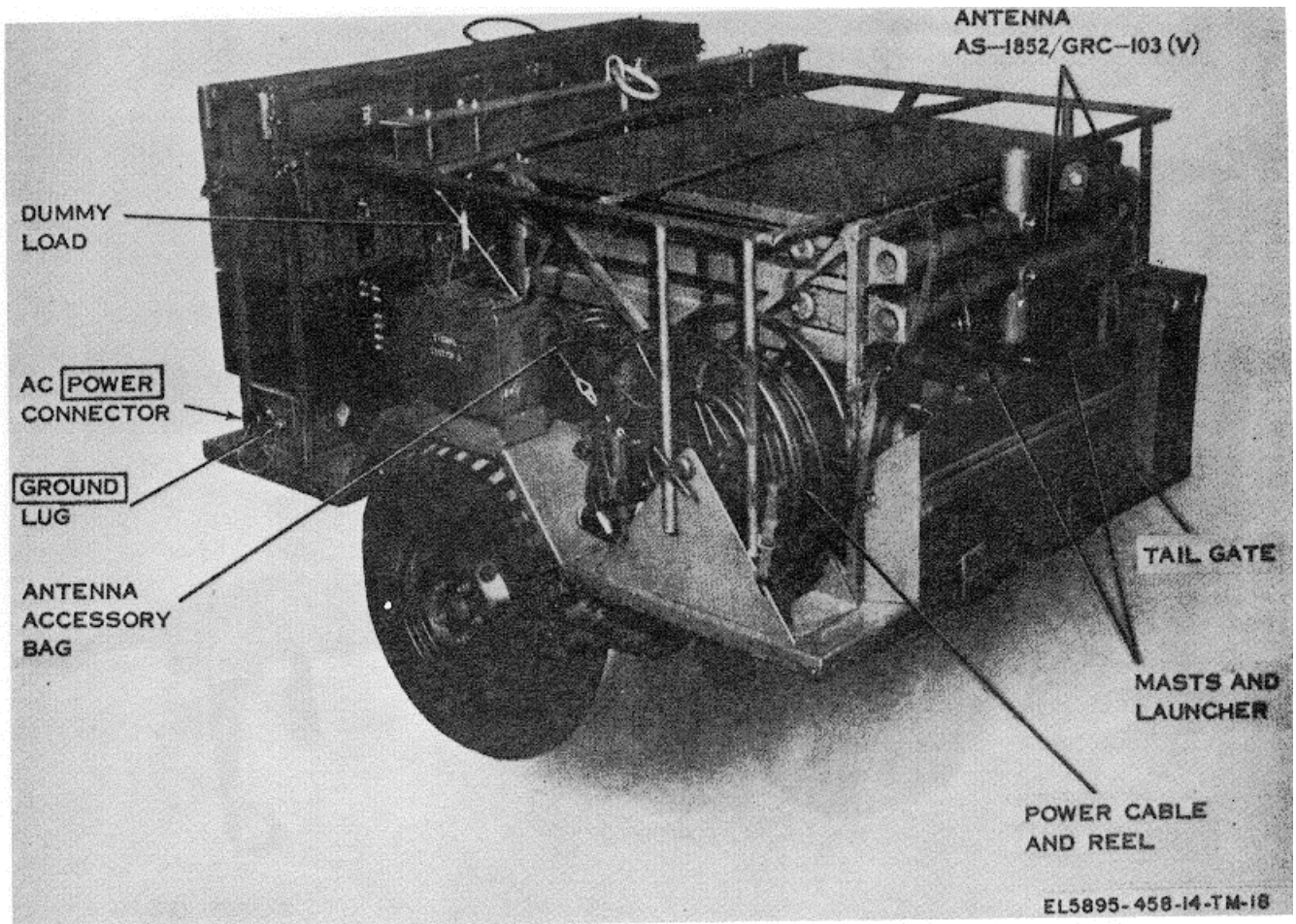

Figure 4-9. AN/MRC-115 (V) trailer, tarpaulin removed, rear roadside view.

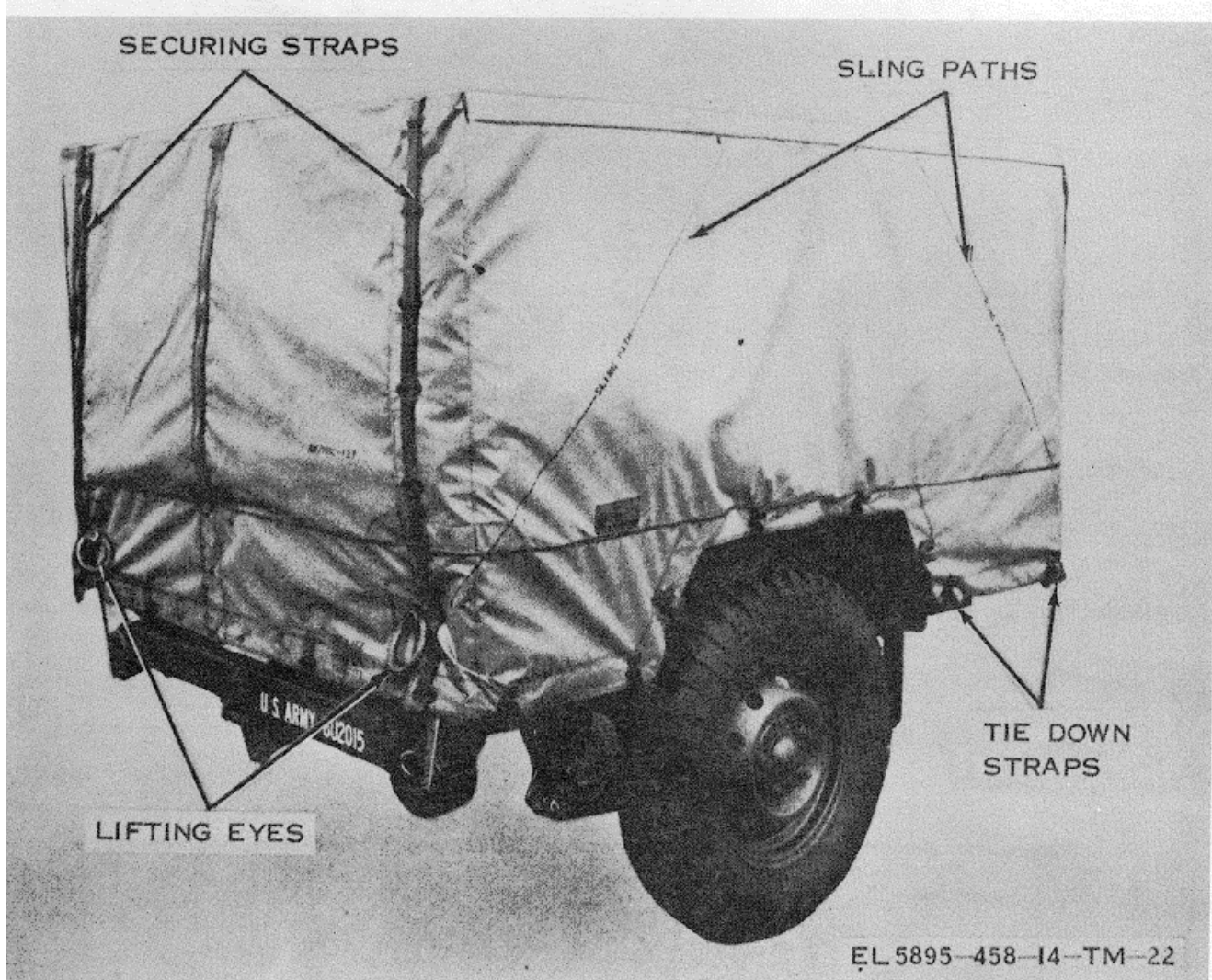

Figure 4-10. Radio Terminal Set AN/MRC-126, or AN/MRC-127, prepared for transit, rear curbside view.



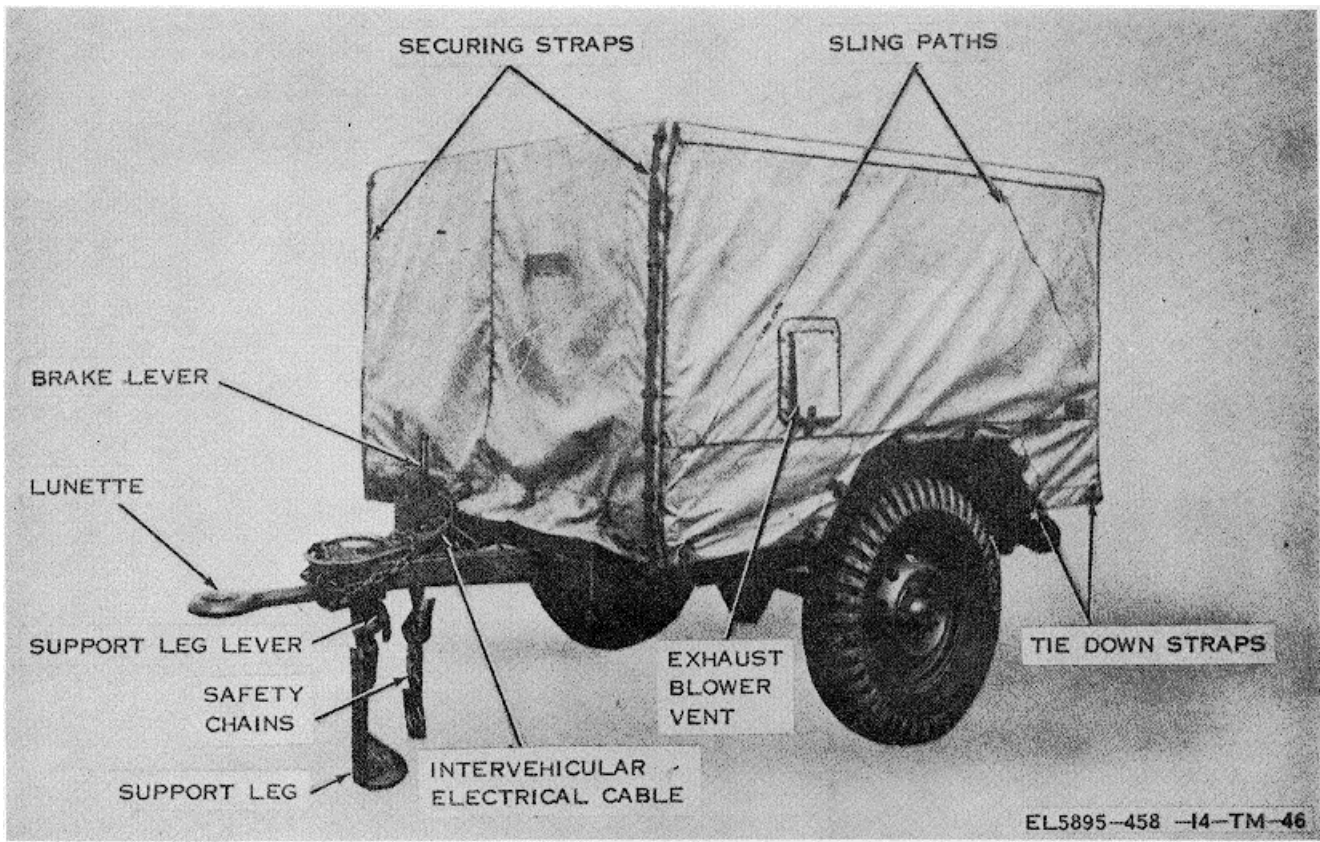

Figure 4-11. Radio Terminal Set AN/MRC-126, or AN/MRC-127, prepared for transit, front roadside view.

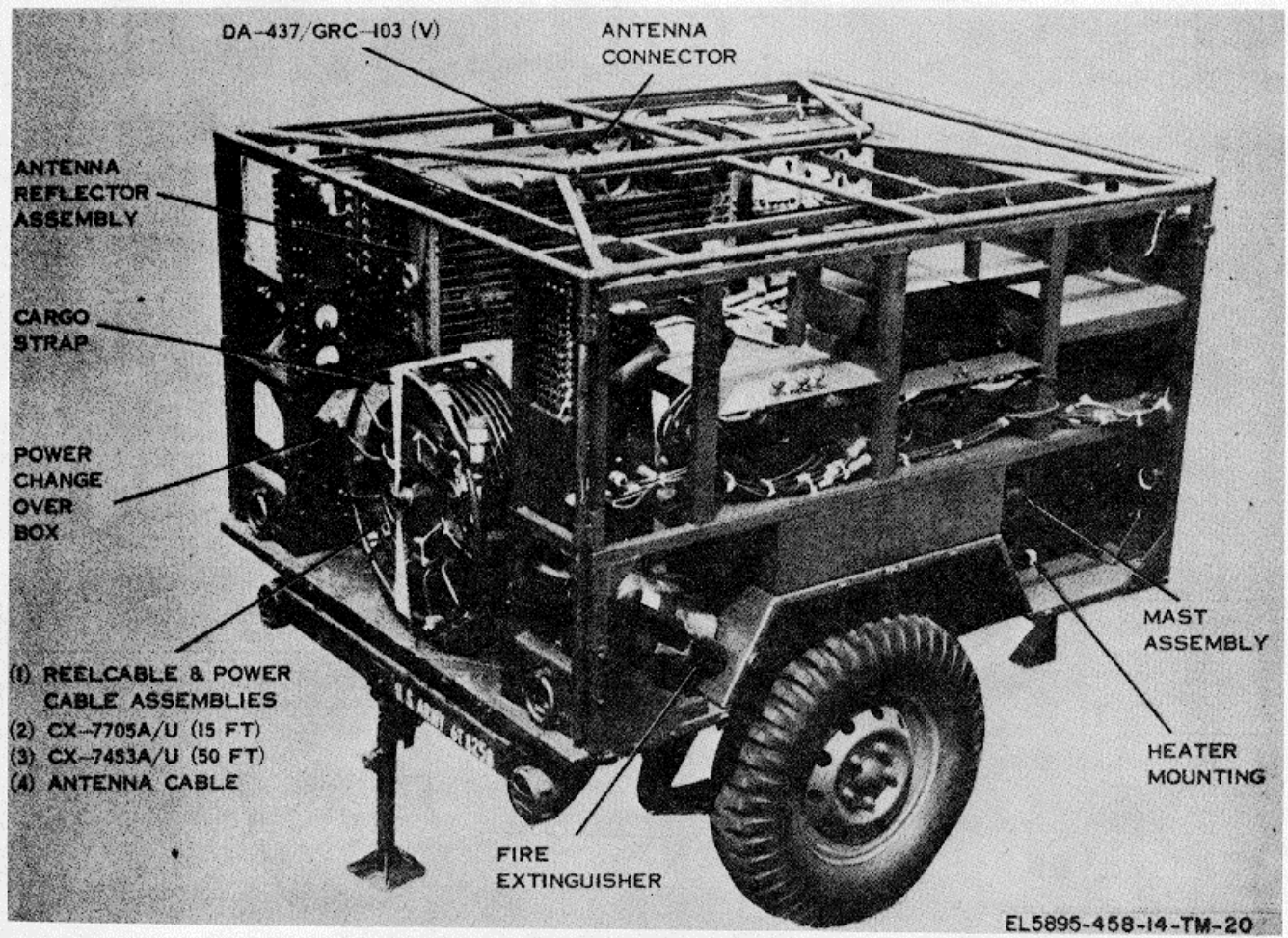

Figure 4-12. Radio Terminal Set AN/MRC-126, tarpaulin removed, rear curbside view.

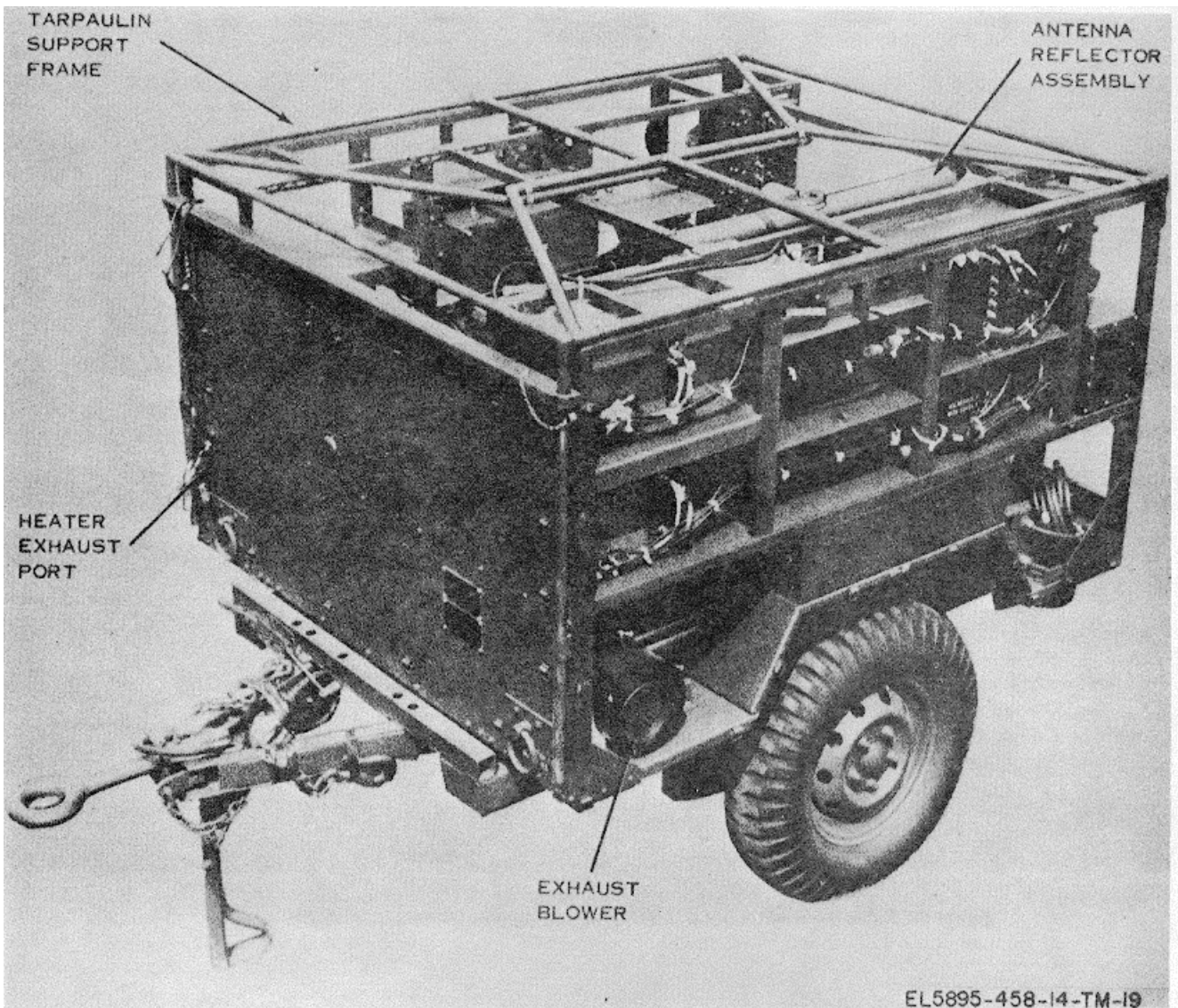

Figure 4-13. Radio Terminal Set AN/MRC-126, tarpaulin removed, front roadside view.

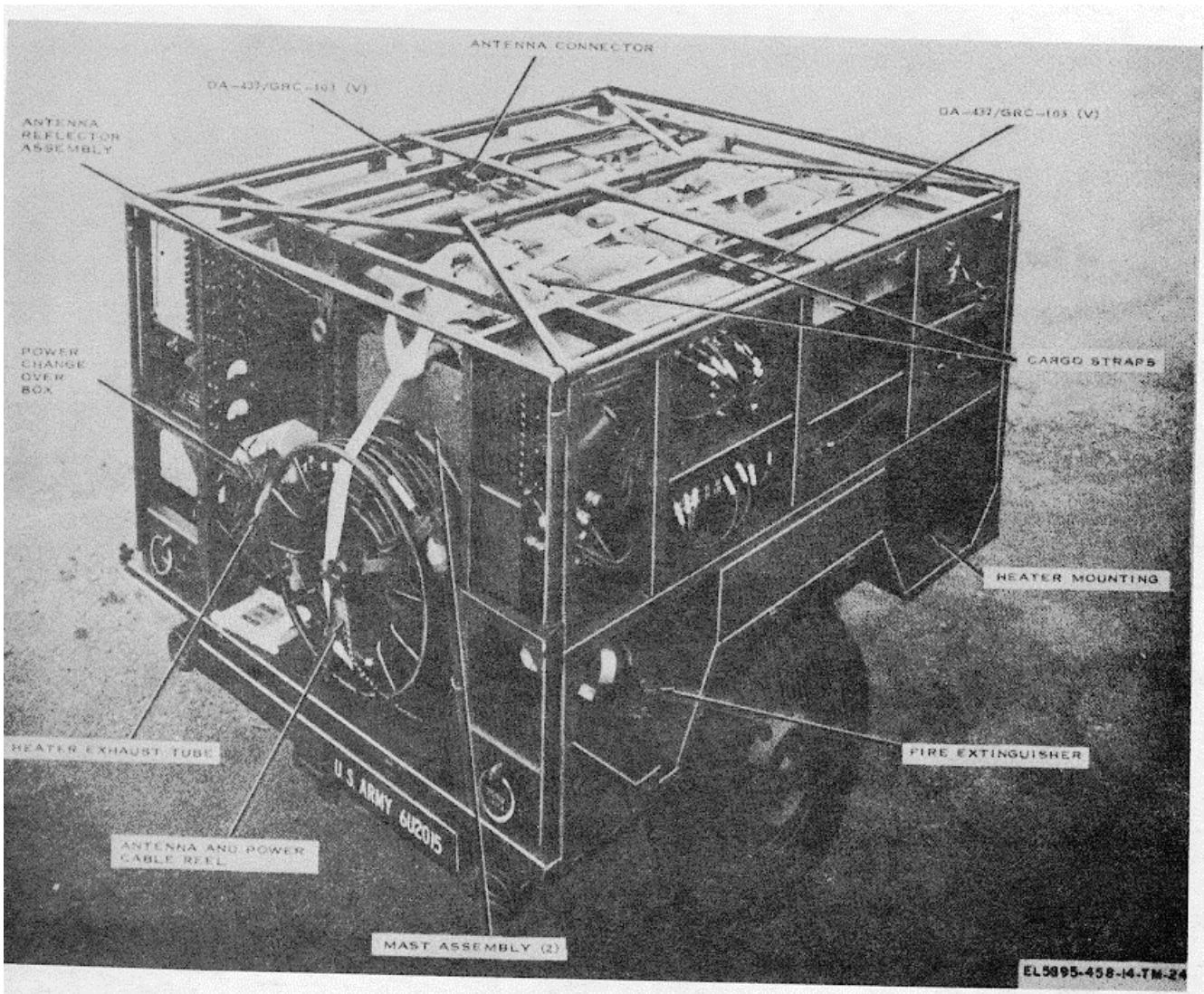

Figure 4-14. Radio Terminal Set AN/MRC-127, tarpaulin removed, rear curbside view.



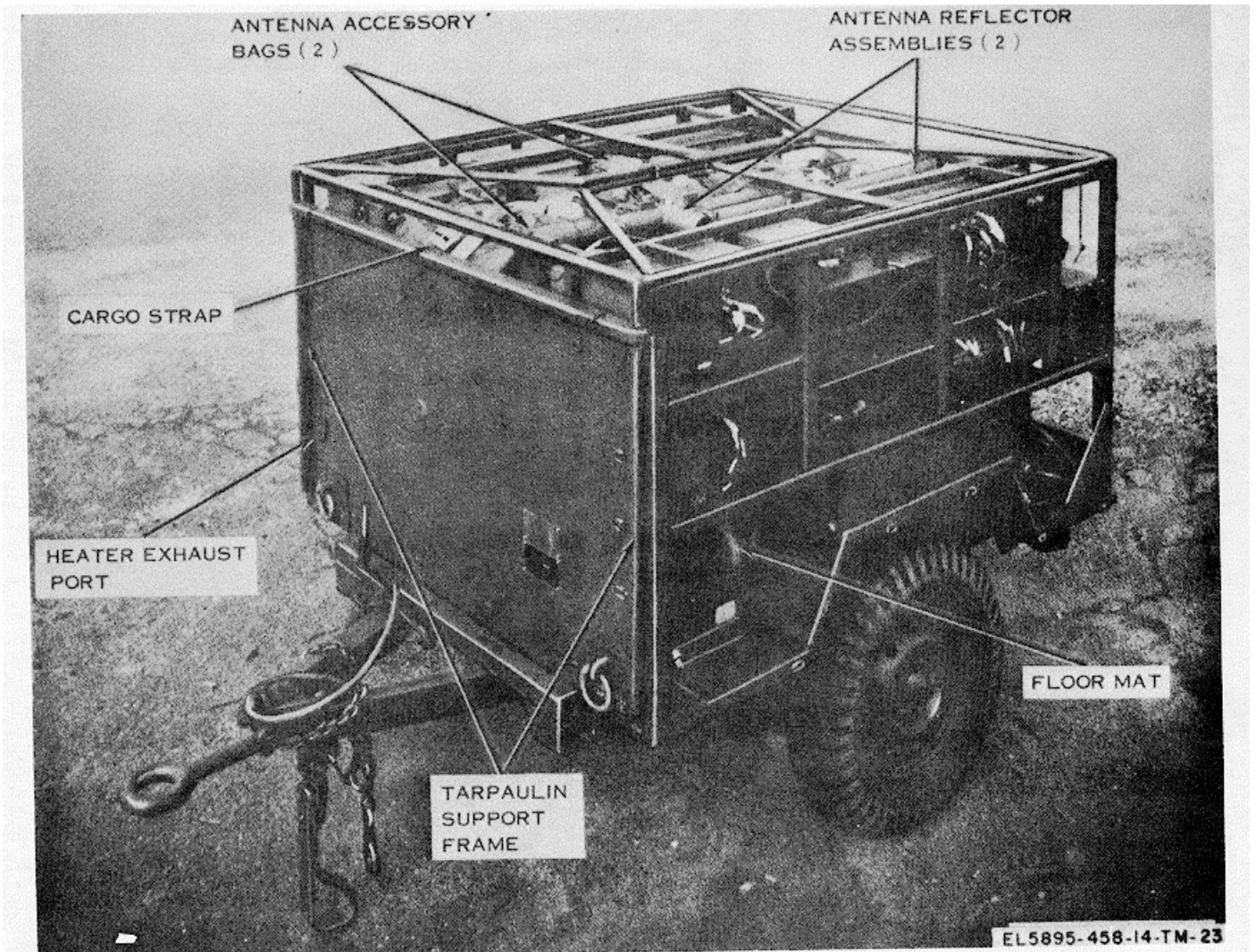

Figure 4-15. Radio Terminal Set AN/MRC-127, tarpaulin removed, front roadside view.

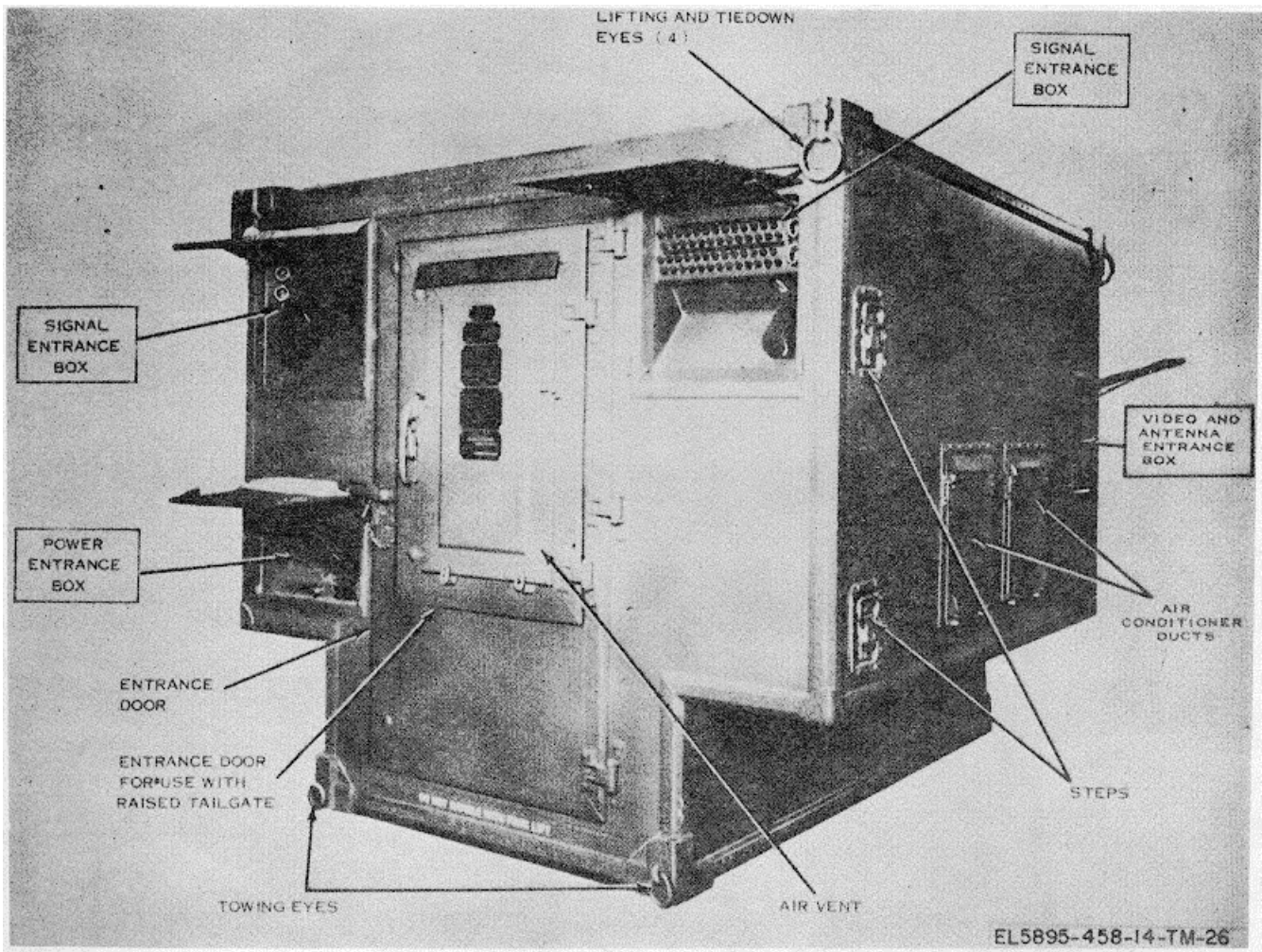

Figure 4-16. Radio Terminal Set AN/TRC-145 (serial No. 1 through 46), rear curbside view.

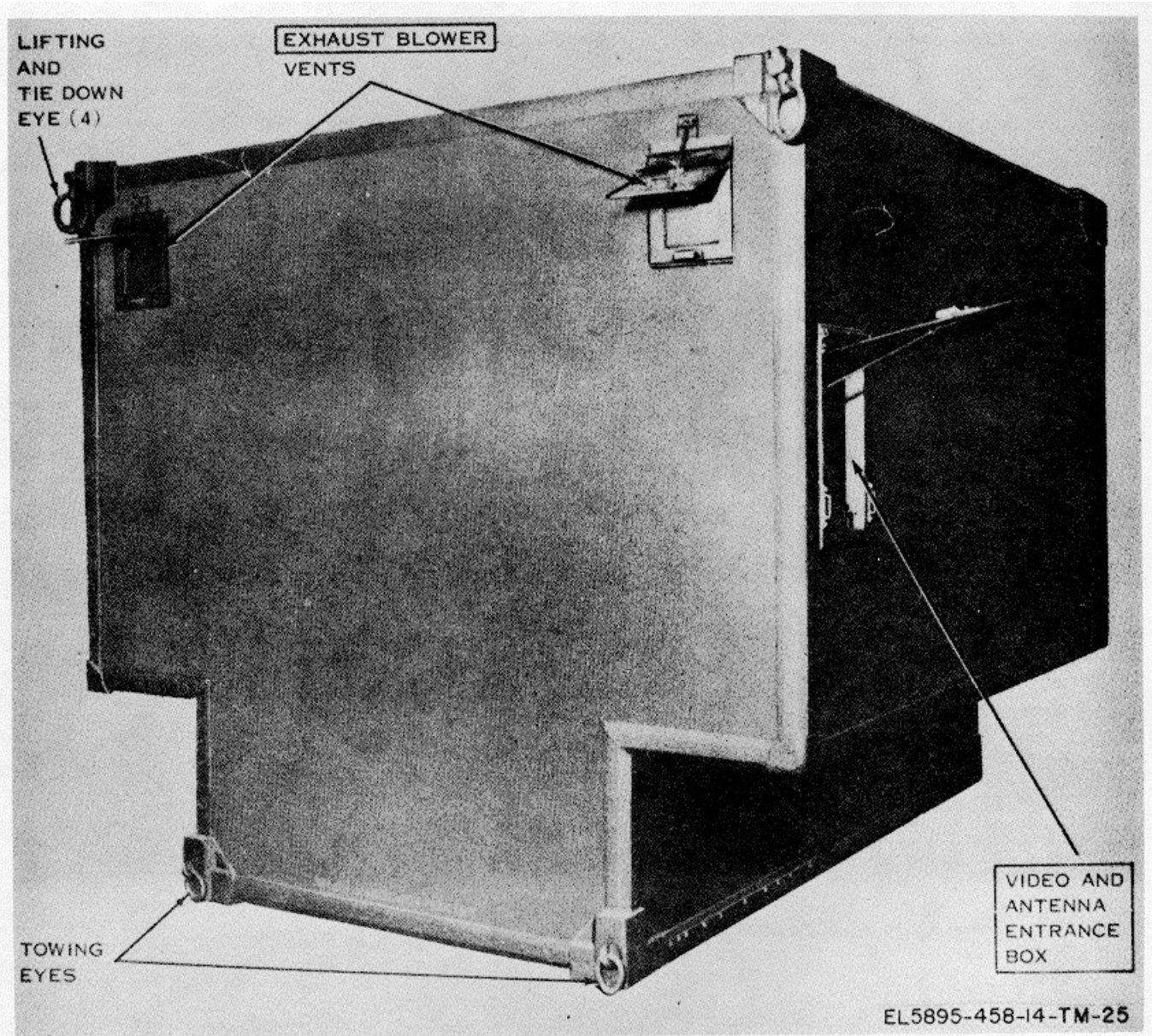

Figure 4-17. Radio Terminal Set AN/TRC-145 (serial No. 1 through 46), front roadside view.

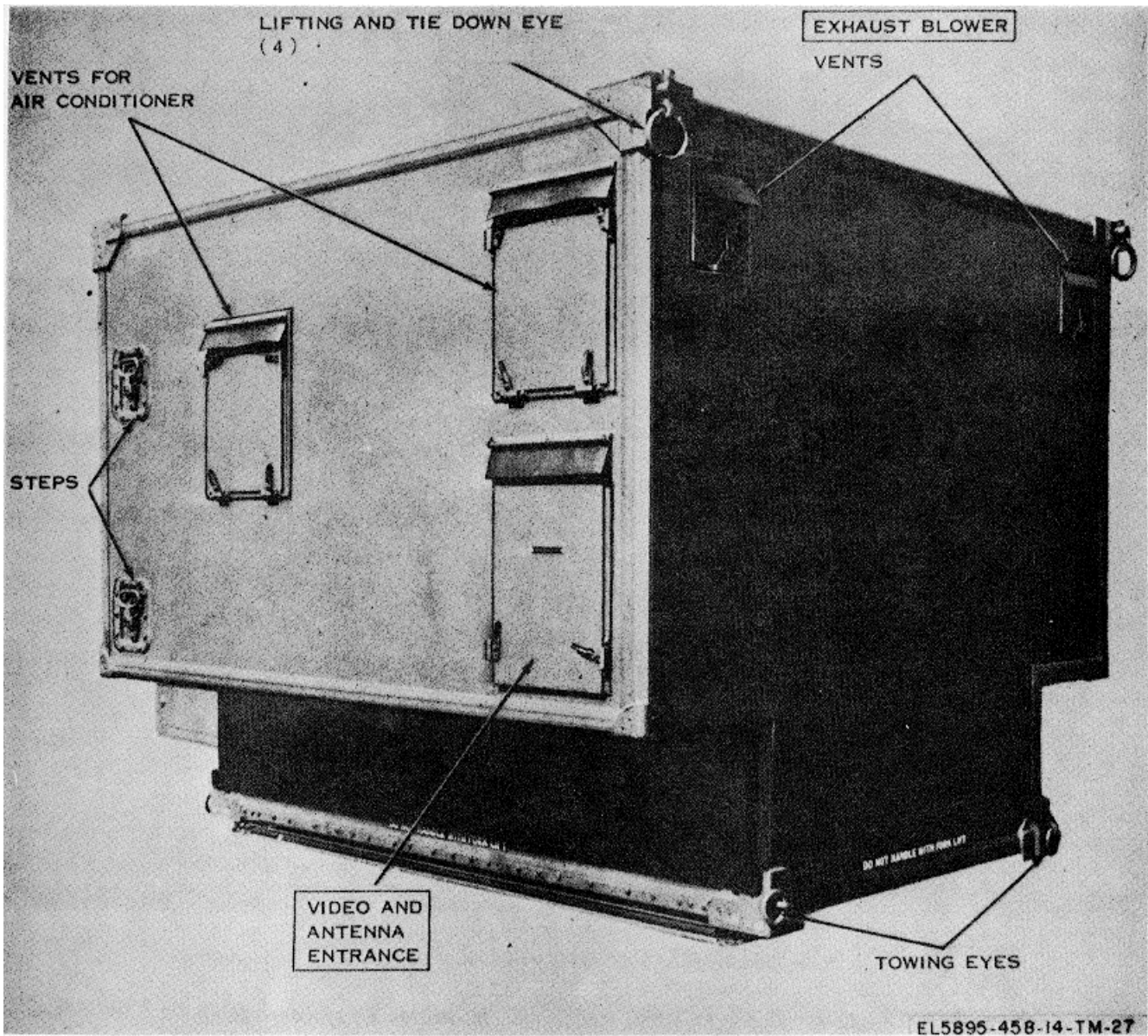

Figure 4-18. Radio Terminal Set AN/TRC-145 (serial No. 47 and above), front curbside view.



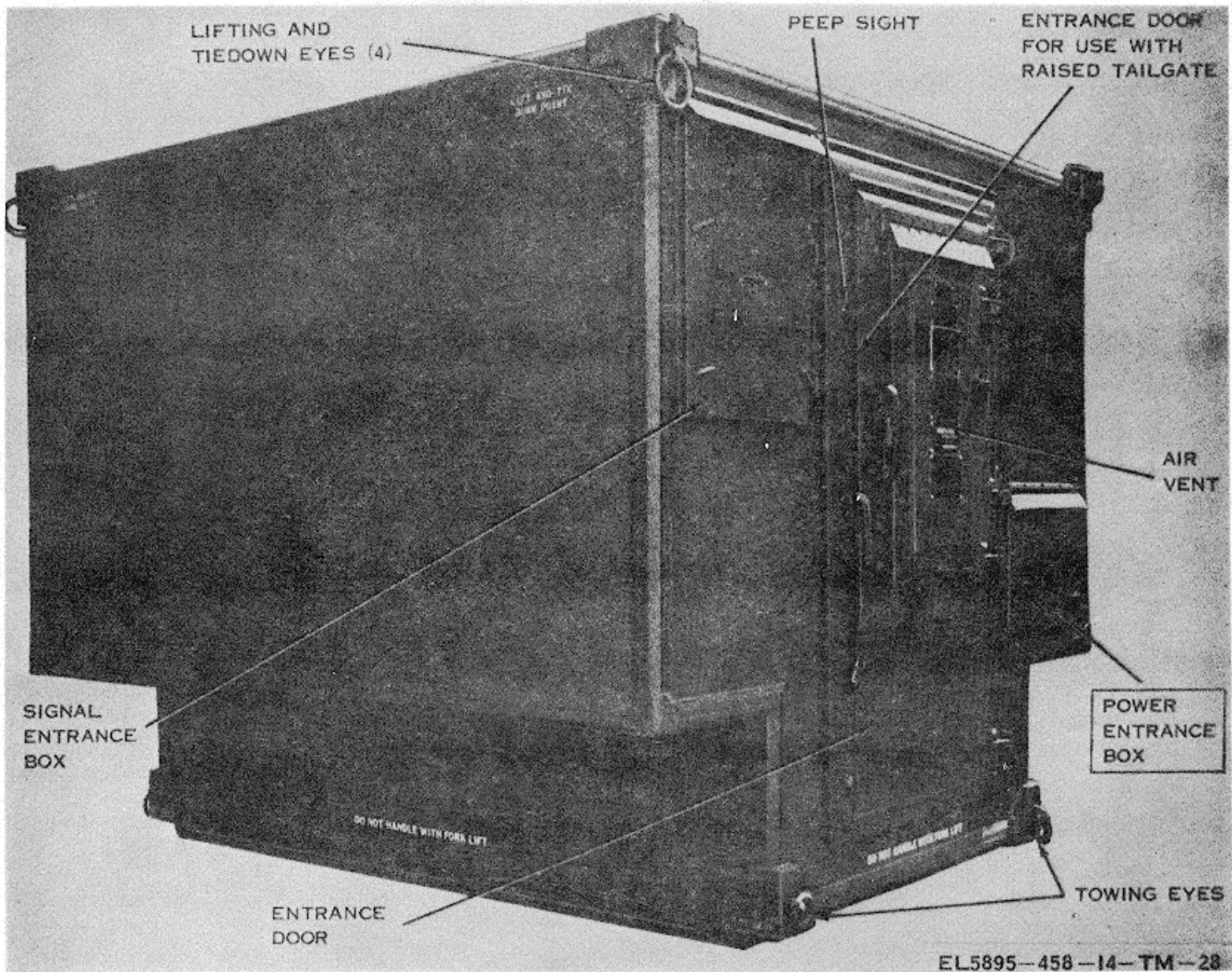

Figure 4-19. Radio Terminal Set AN/TRC-145 (serial No. 1 through 46), rear roadside view.

**4-2. Terminal Set, Telephone AN/ TCC-655**

a. Use. Terminal Set, Telephone AN/TCC-65 (fig 4-1 through 4-4) provides secure or nonsecure multiplex cable terminal or repeater facilities for forward area pulse code modulator (pcm) communication systems. Although the AN/TCC-65 is primarily a cable terminal, it may be used with other equipment such as Repeater Set, Radio AN/TRC-113 for radio terminal applications (fig. 6-2). Interiors of the AN/TRC-65 are shown in figures 4-20 through 4-29.

b. Major Characteristics.

Possible system application:

12/24/48-channel pcm	
cable repeater .....	2
24-channel pcm cable	
repeater with 12-channel	
drop and insert .....	2
12-channel pcm	
cable terminal .....	1
24-channel pcm	
cable terminal .....	2
Power consumption (maximum) .....	2,922watts
Weight .....	1,302 lb



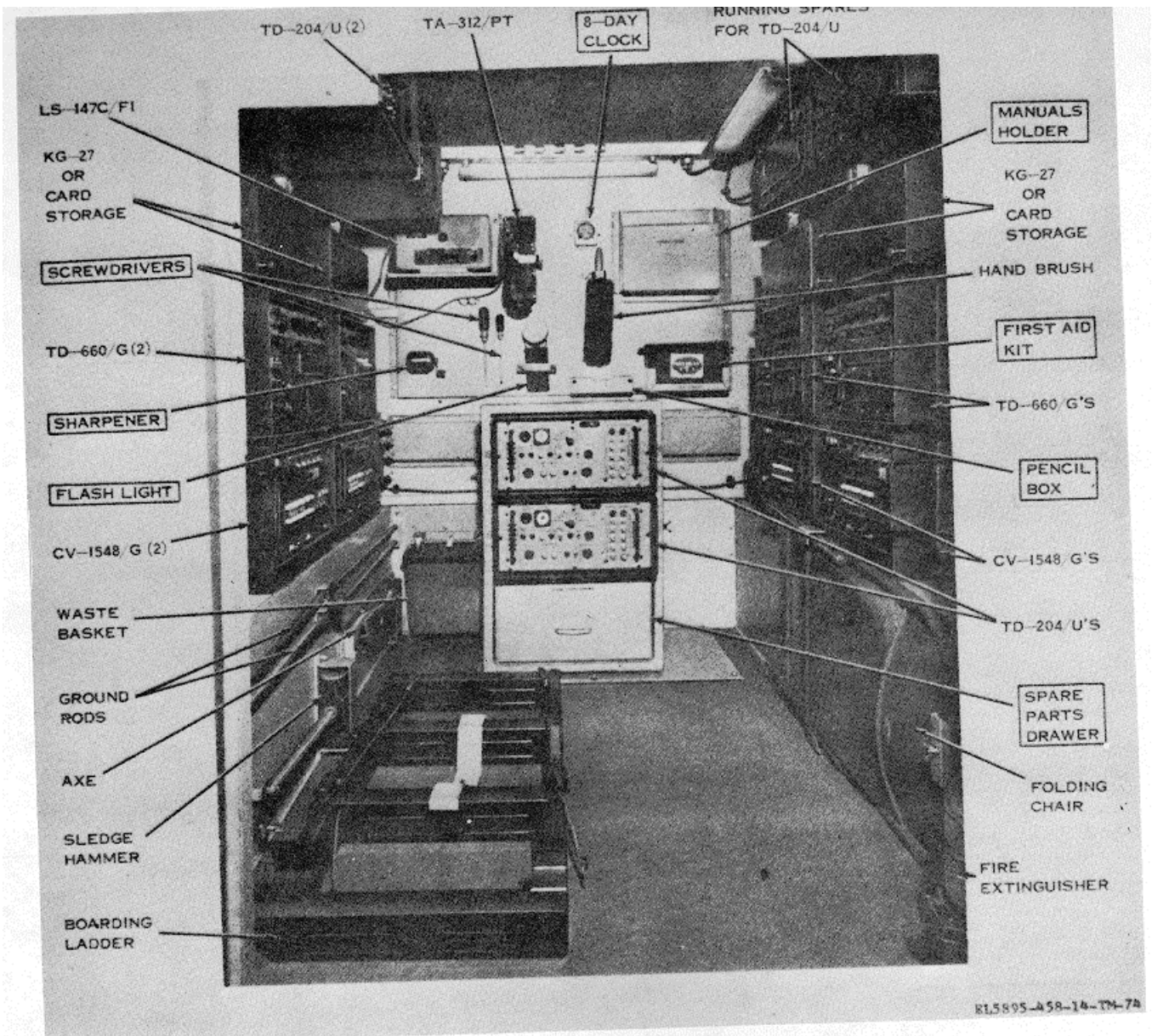

Figure 4-20. Terminal, Telephone AN/TCC-65, front view (serial No. 1 through 19).

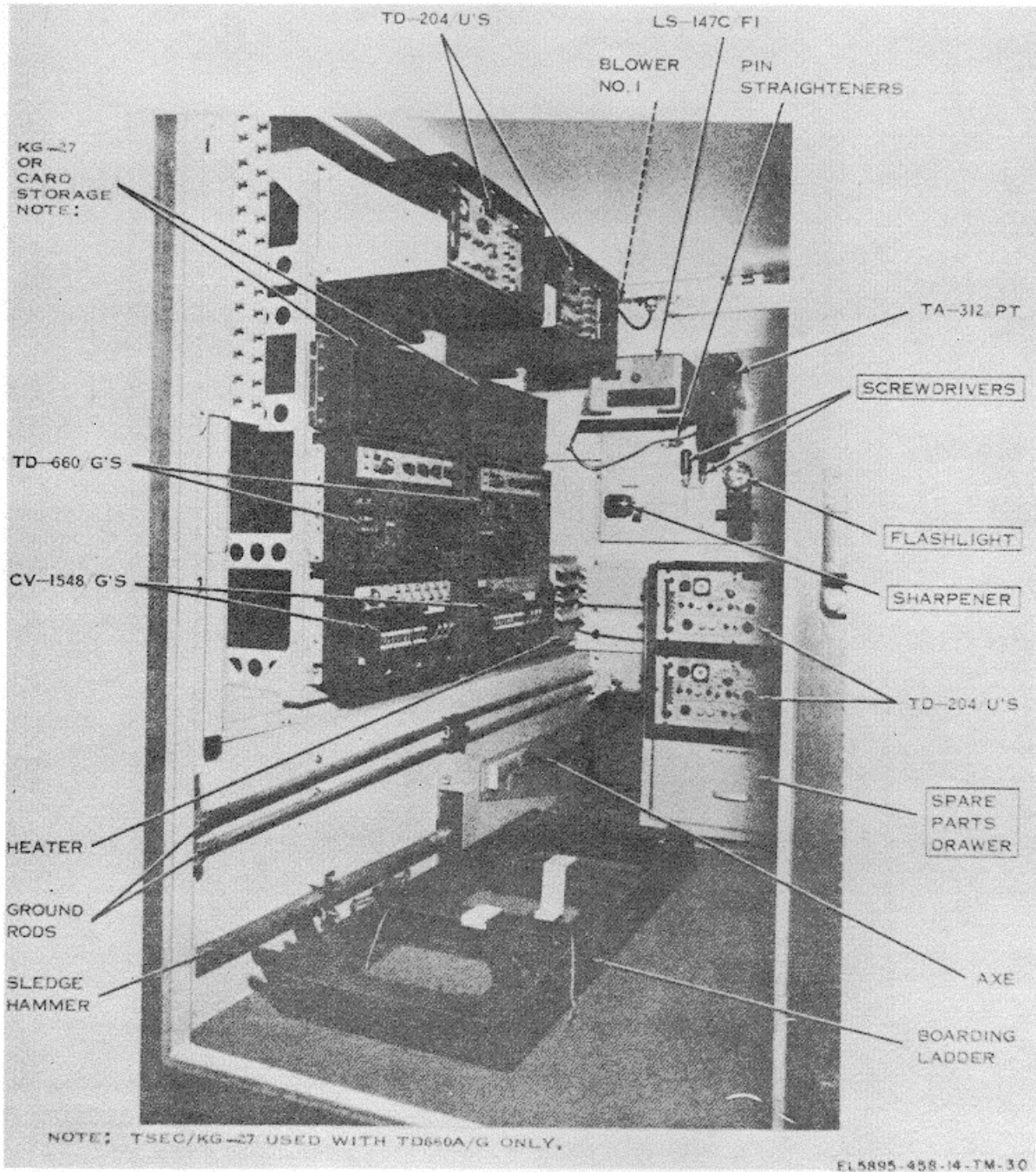

Figure 4-21. Terminal Telephone AN/TCC-65, interior front roadside view (serial No. 1 through 19)

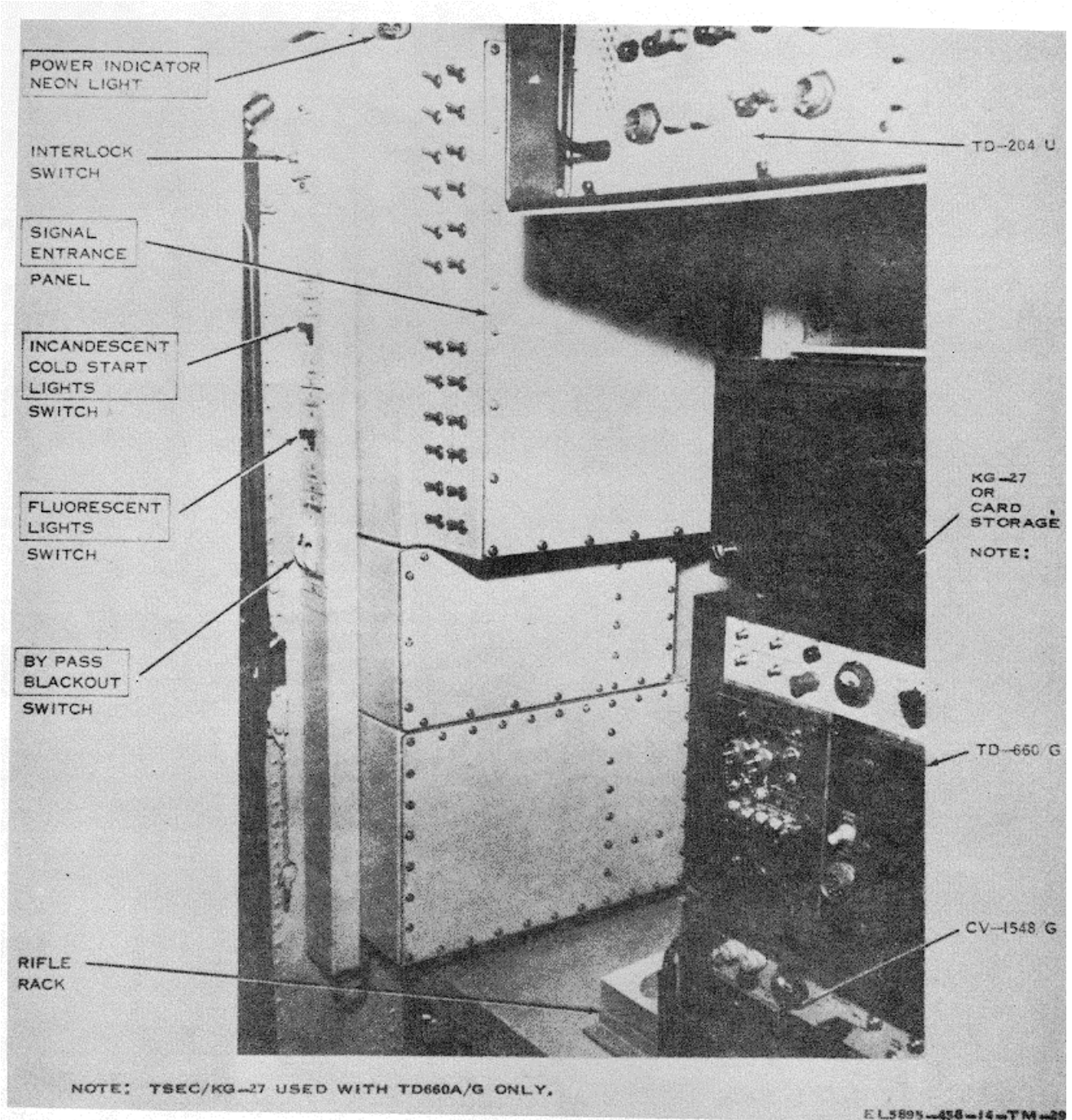

Figure 4-22. Terminal, Telephone AN/TCC-65, interior rear roadside view (serial No.1 through 19)



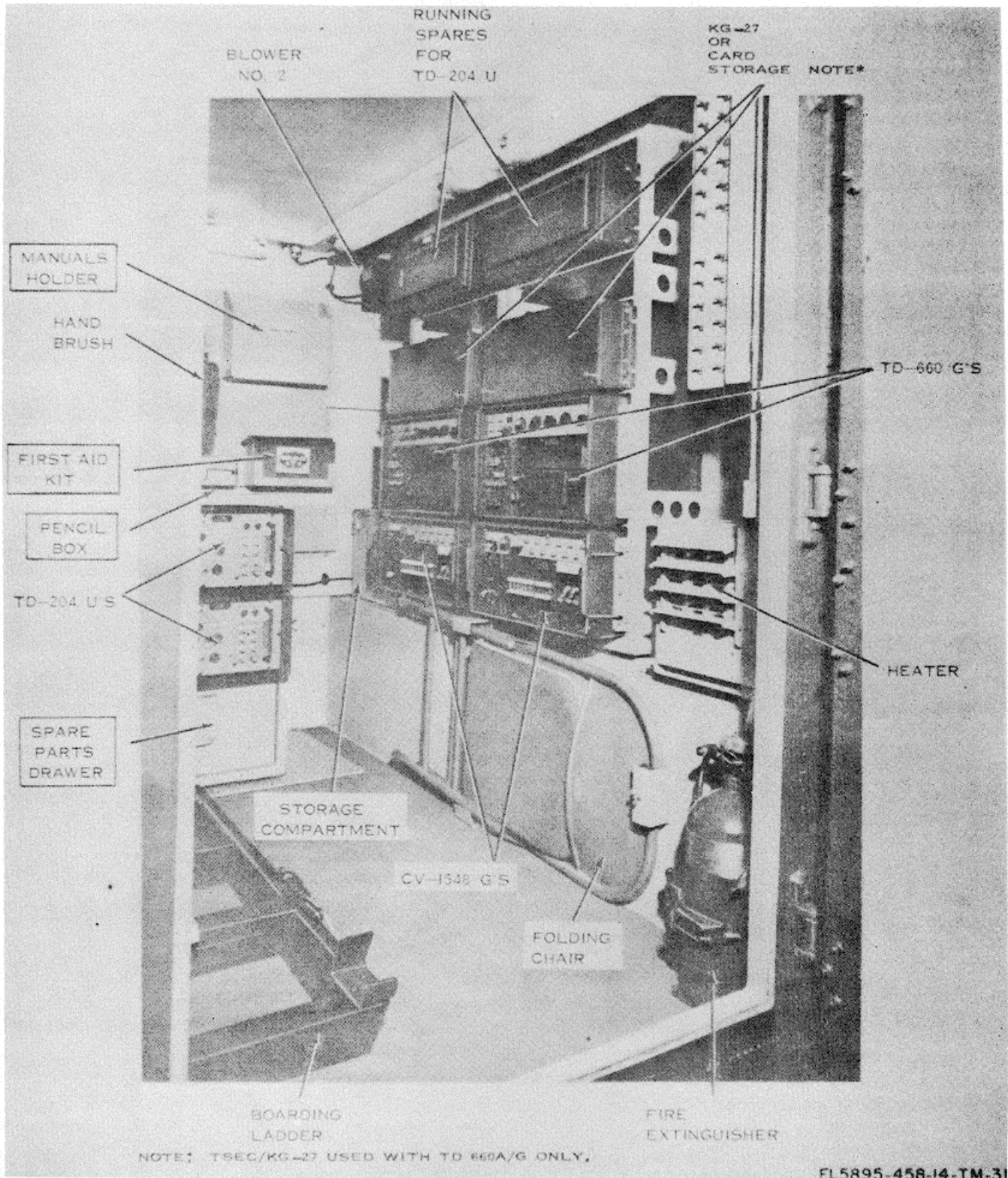

Figure 4-23. Terminal, Telephone AN/TCC-65, interior front curbside view (serial No. 1 through 19)

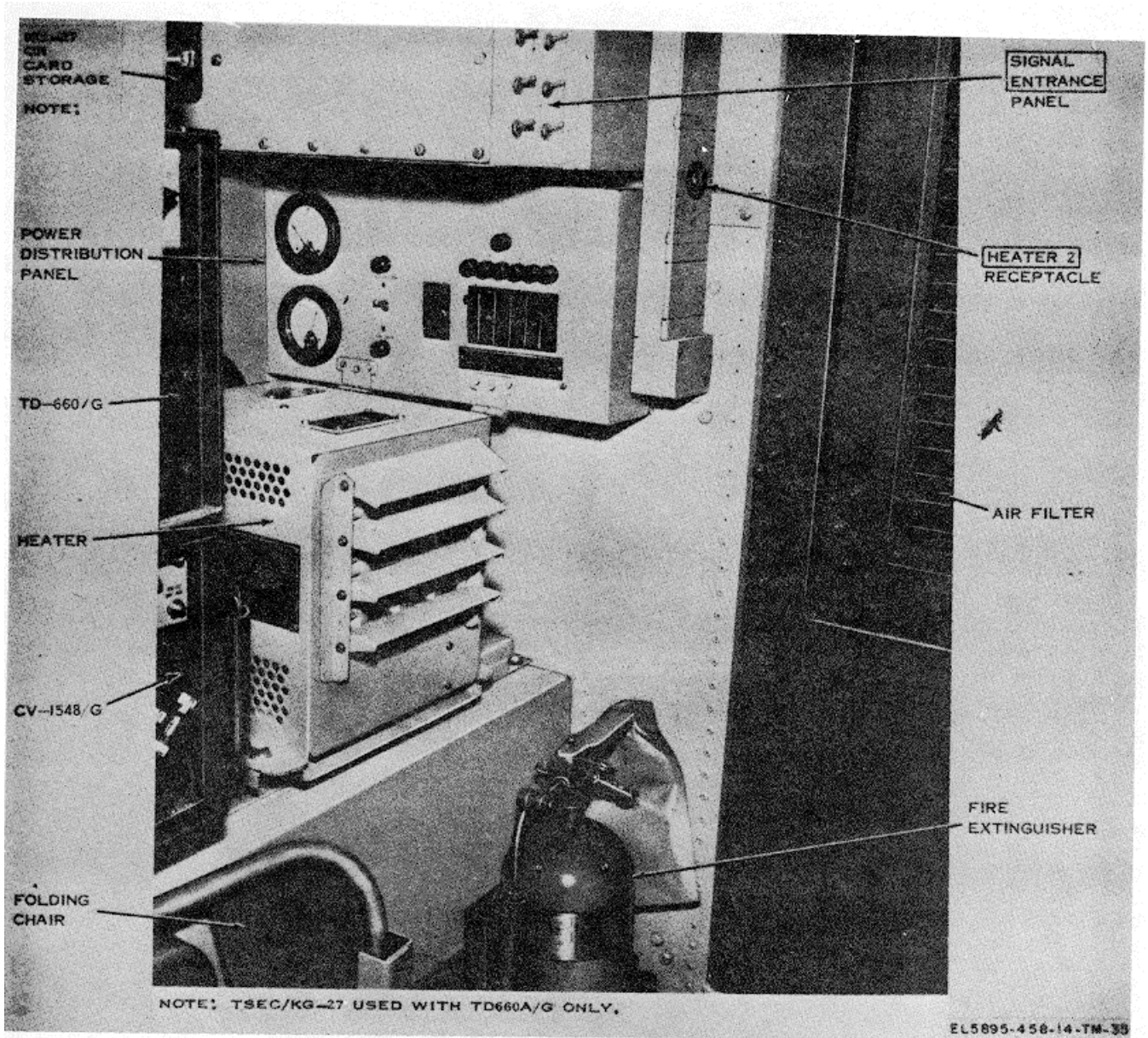

Figure 4-24. Terminal AN/TCC-65, interior rear curbside view (serial No. 1 through 19).



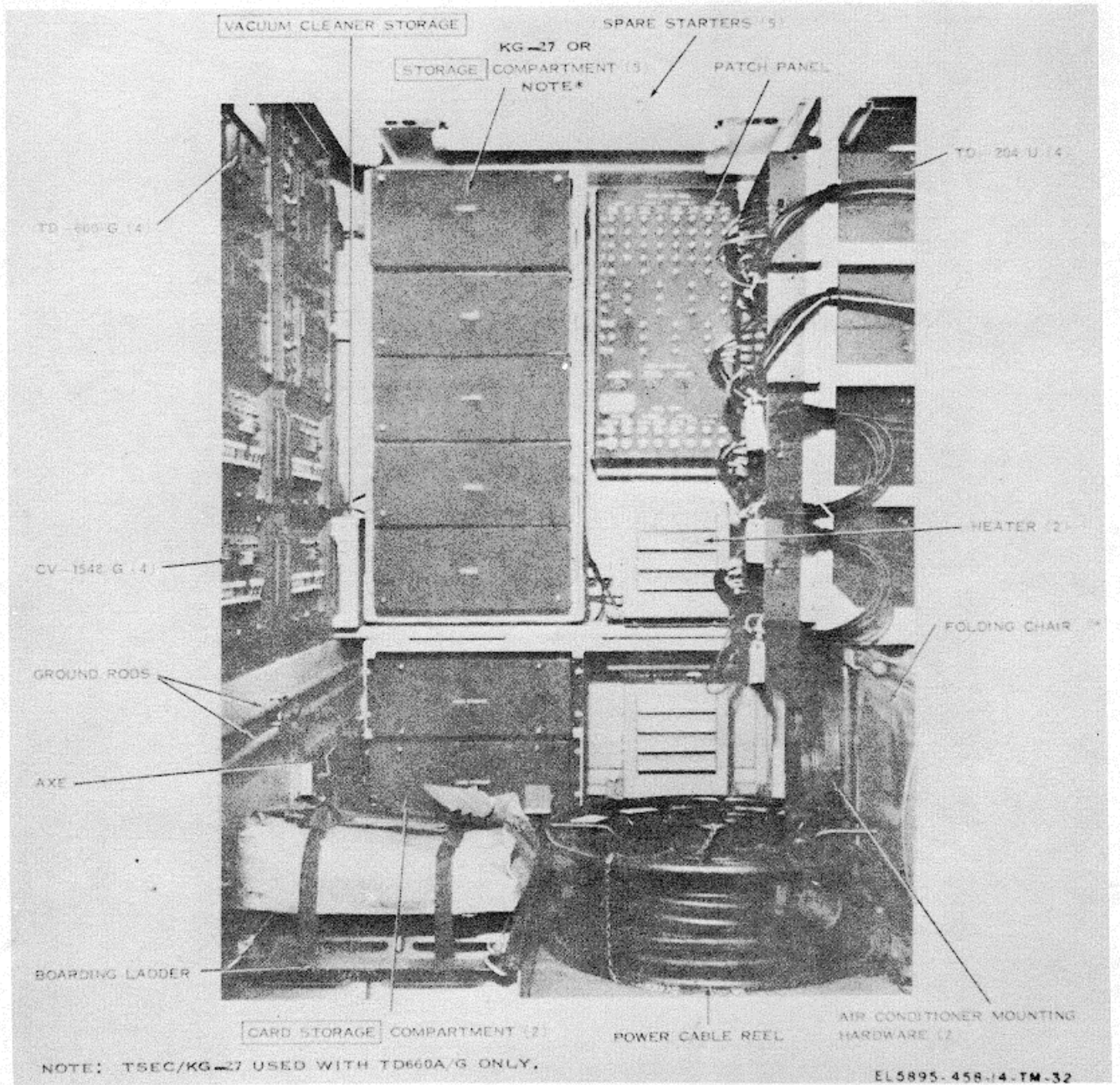

Figure 4-25. Terminal, Telephone AN/TCC-65, interior front view (serial No. 20 and above)

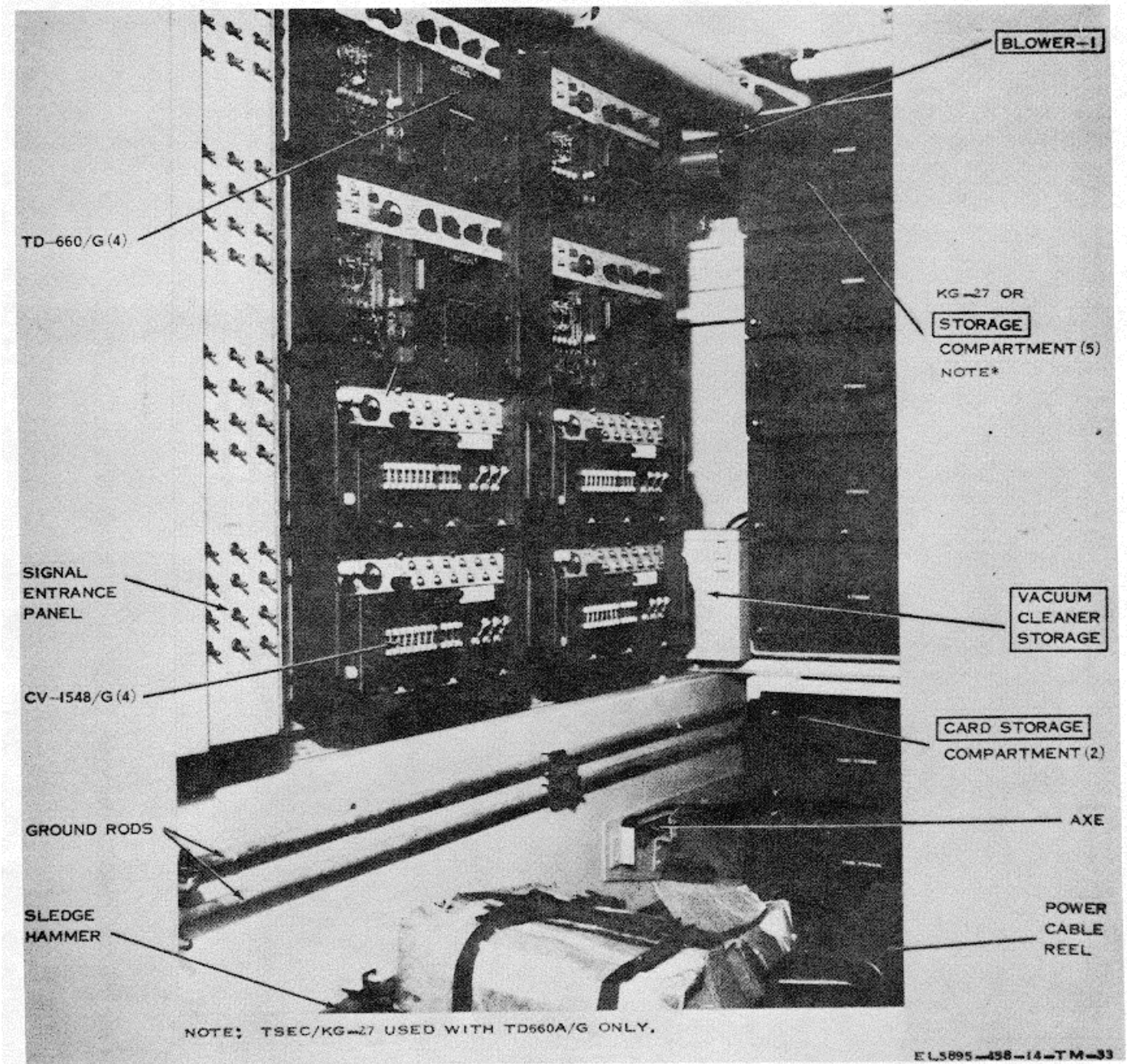

Figure 4-26. Terminal, Telephone AN/TCC-65, interior front roadside view (serial No. 20 and above)

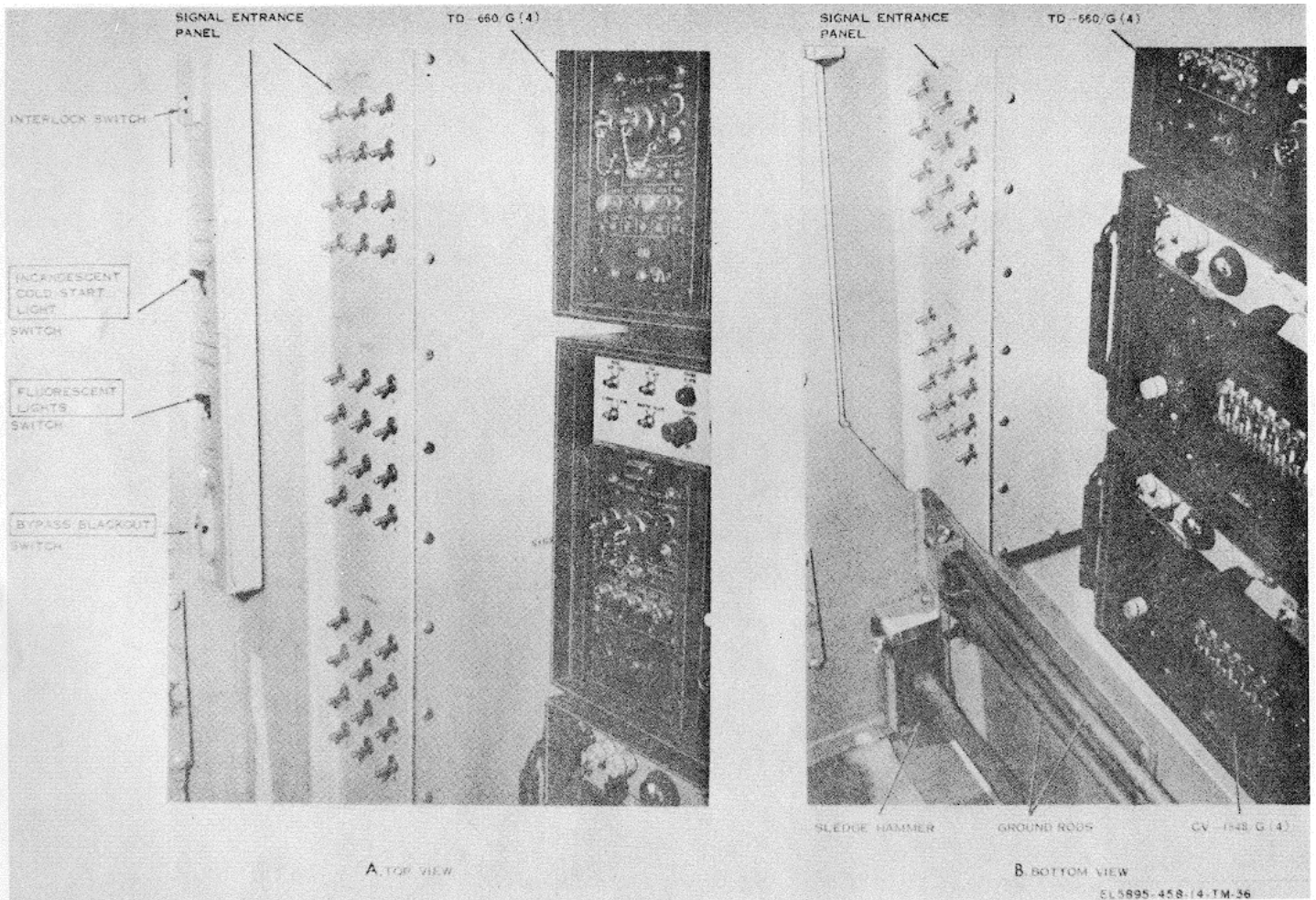

Figure 4-27. Terminal, Telephone AN/TCC-65, interior rear roadside view (serial No. 20 and above).



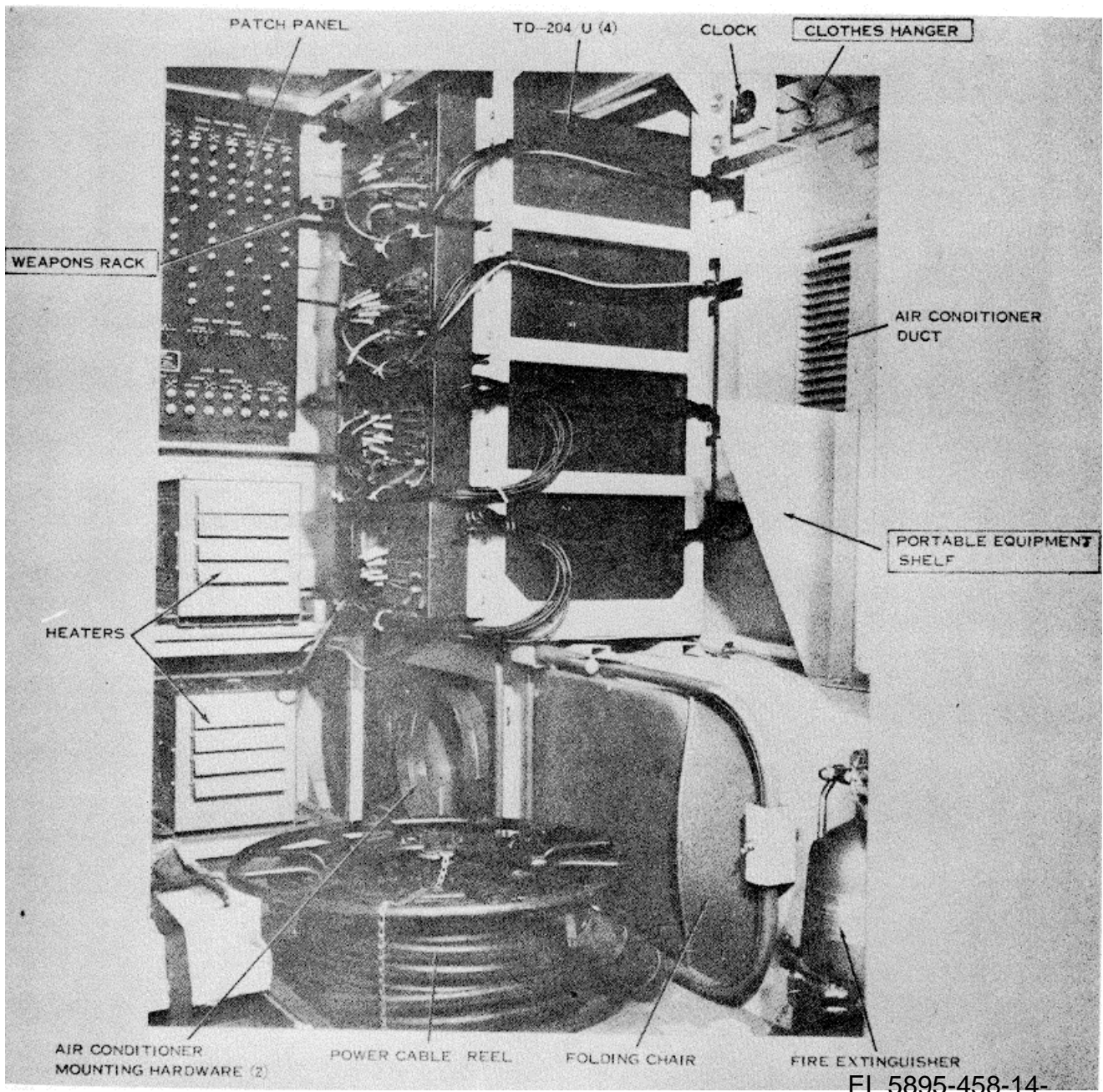

Figure 4-28. Terminal, Telephone AN/TCC-65, interior front curbside view (serial No.20 and above).

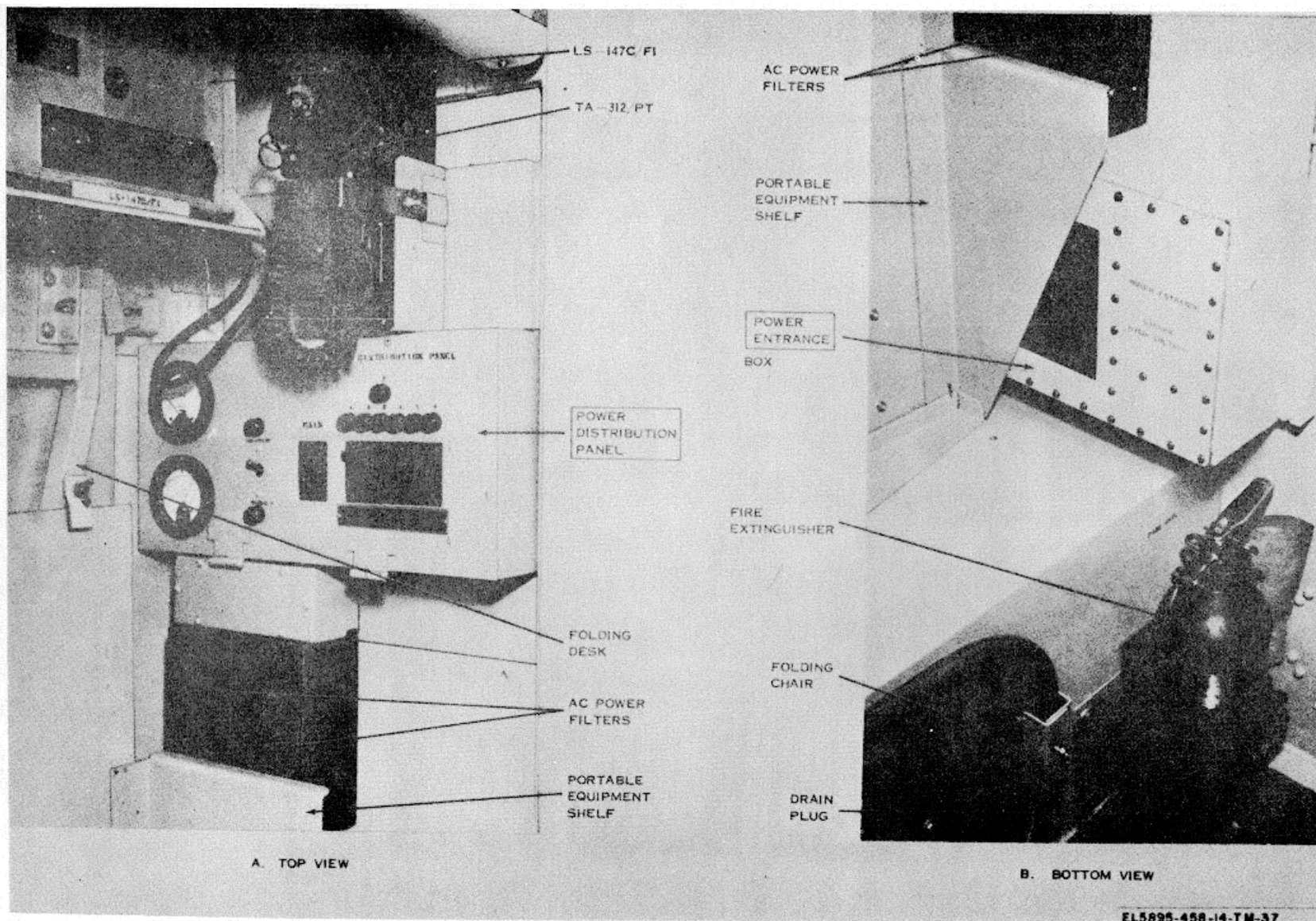

Figure 4-29. Terminal, Telephone AN/TCC-65, interior rear curbside view (serial No. 20 and above).



**4-3. Repeater Set, Radio AN/ TRC-113**

a. *Use.* Repeater Set, Radio AN/TRC-113 (fig. 4-5 and 4-6) provides radio and/or cable repeater facilities for forward area pulse, code modulation (pcm) communication systems. The AN/TRC-113 consists of two groups of equipment, and may be used in a 12- or 24-channel pcm system. Although the AN/TRC-113 is primarily a radio or cable repeater, it may be used with other equipment such as Terminal, Telephone AN/TCC-65 for radio terminal applications. Typical applications

of the AN/TRC-113 are shown in figure 6-3. Interiors of the AN/TRC-113 are shown in figures 4-30 through 4-34.

b. *Major Characteristics.*

Possible system applications:

12/24/48-channel pcm cable repeater .....	2
6/12-channel pcm radio repeater .....	2
12-channel pcm cable to radio conversion .....	1
Power consumption (maximum) .....	3,380 watts
Weight .....	1,275 lb

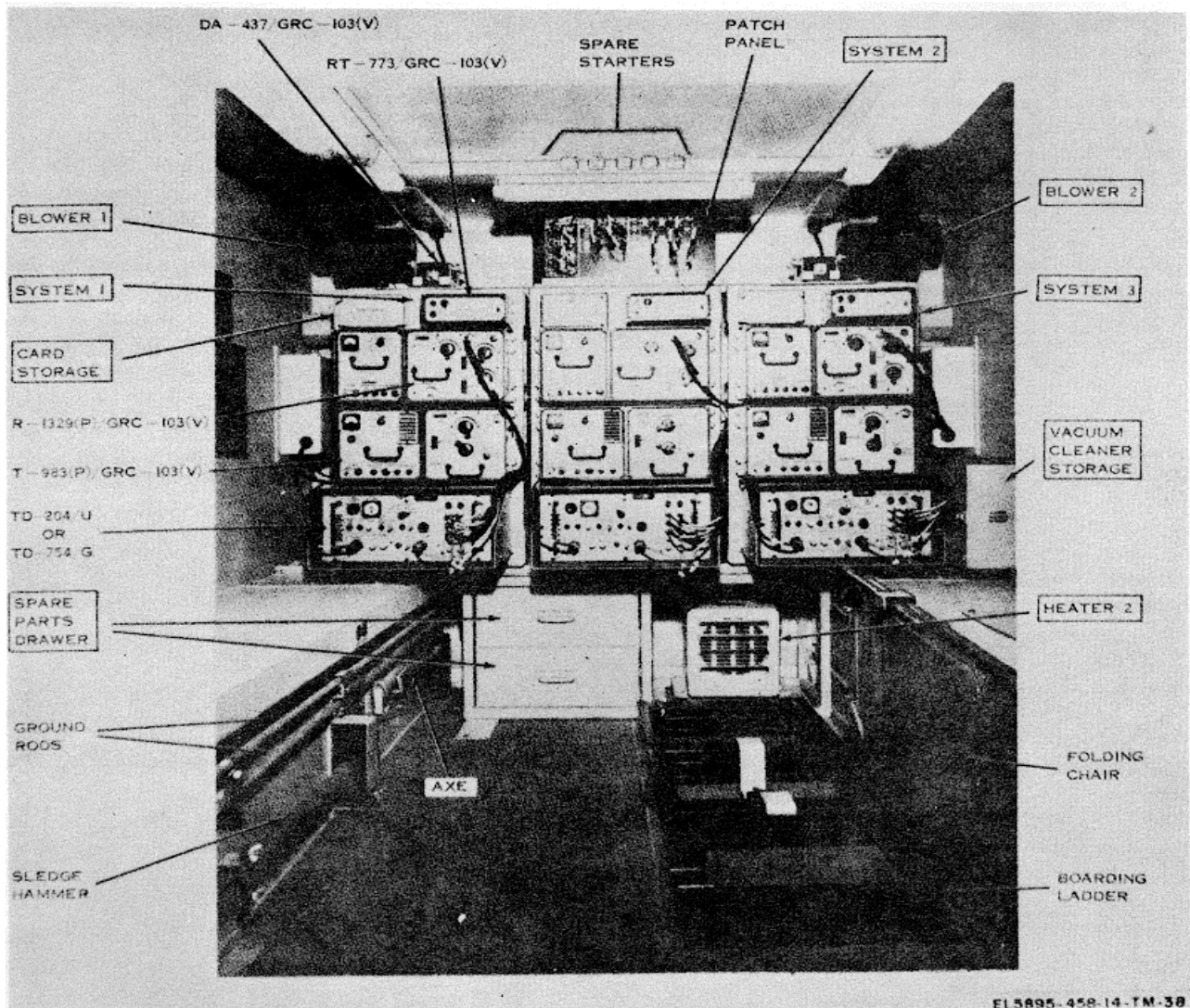

Figure 4-30. Repeater Set, Radio AN/TRC-113, interior front view.

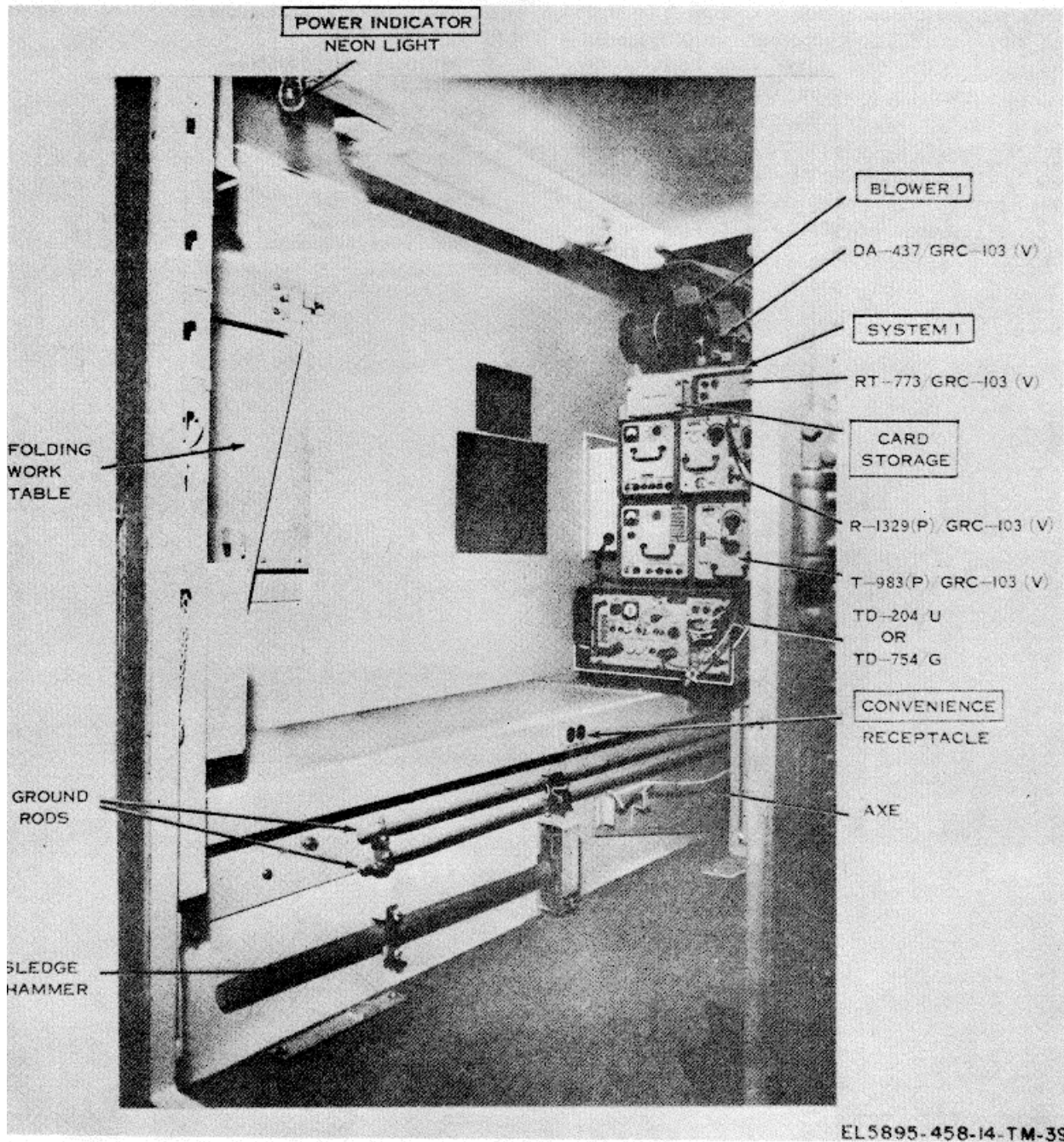

Figure 4-31. Repeater Set, Radio AN/TRC-113, interior front roadside view.

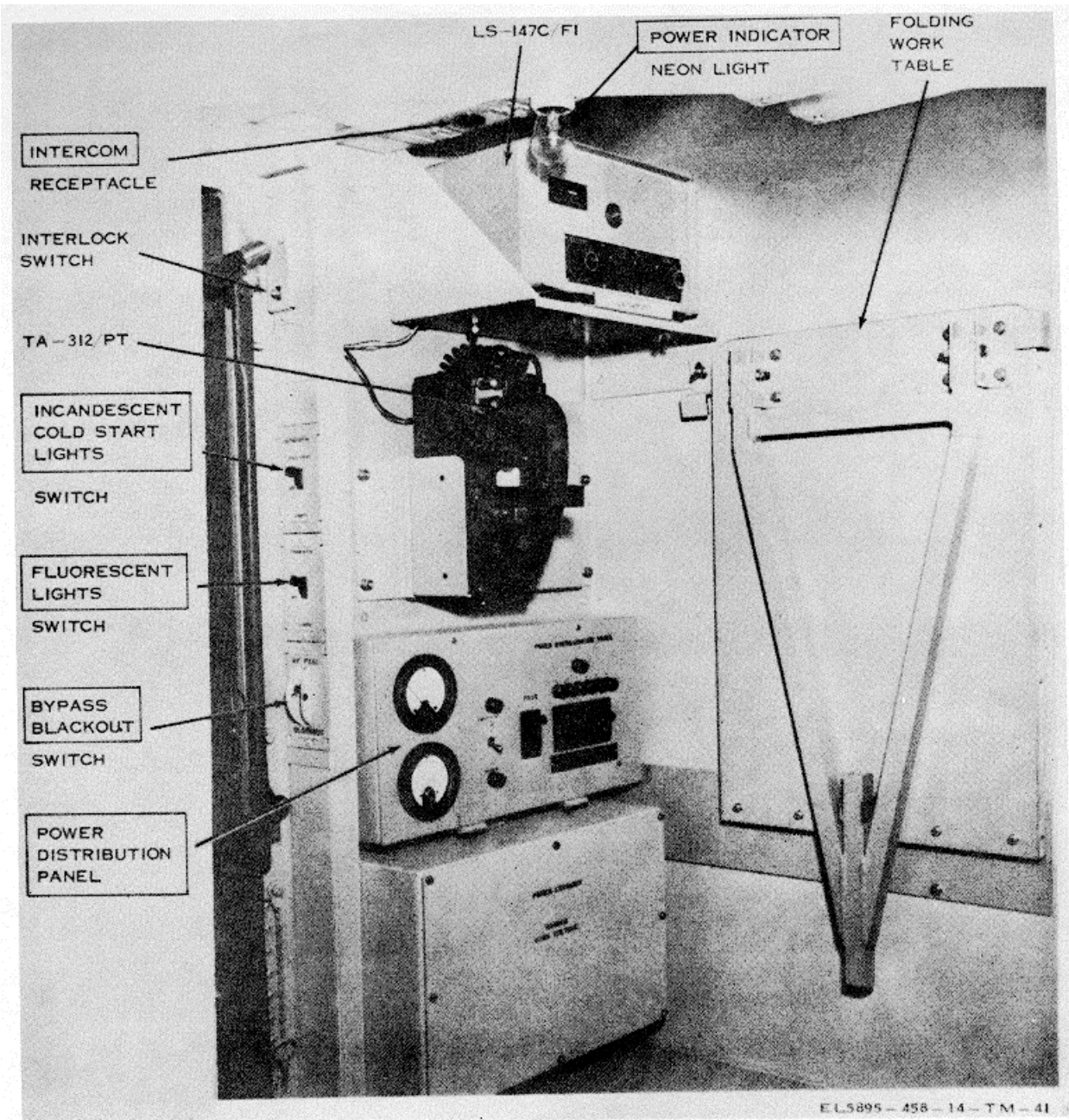

Figure 4-32. Repeater Set, Radio AN/TRC-113, interior rear roadside view.



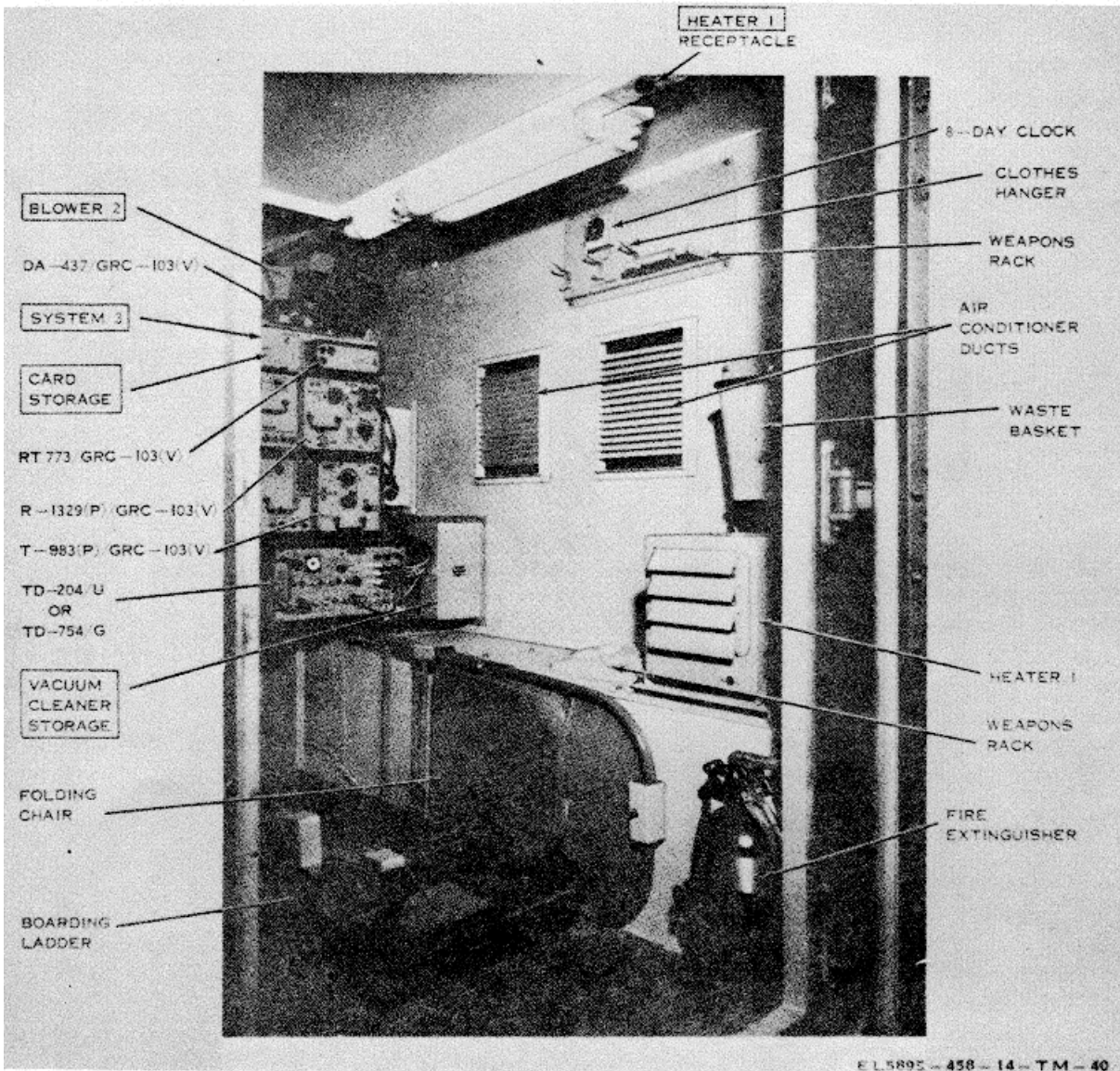

Figure 4-33. Repeater Set, Radio AN/TRC-113, interior front curbside view.

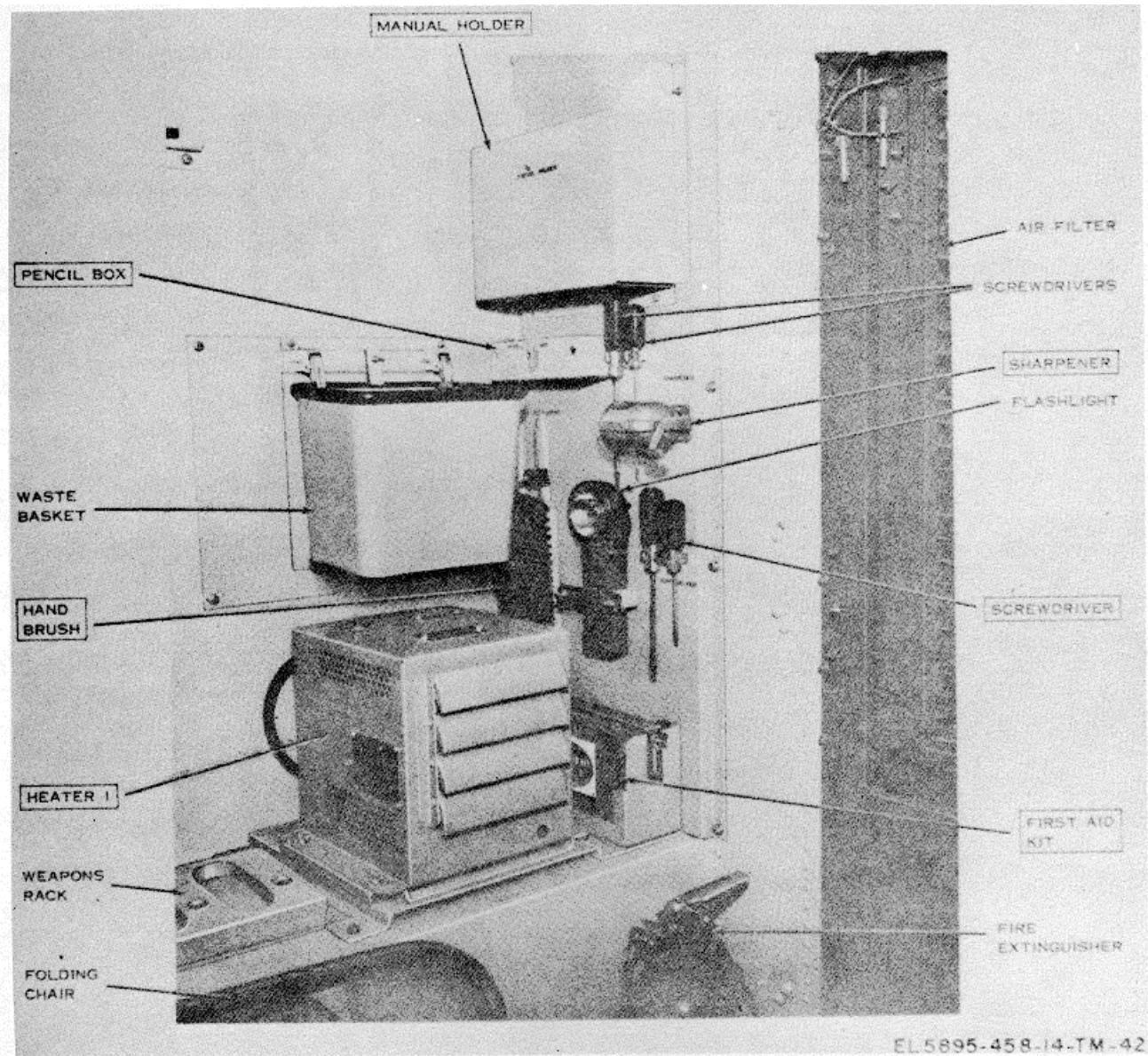

Figure 4-34. Repeater Set, Radio AN/TRC-113, interior rear curbside view.

**4-4. Radio Terminal Set AN/MRC-115(V)**

a. Use. Radio Terminal Set AN/MRC-115(V) (fig. 4-7, 4-8, and 4-9) provides nonsecure radio terminal facilities for forward area units. The AN/MRC-115(V) contains two complete equipment sets, each of which provides 6- or 12- channel pulse-code-modulation (pcm) terminal facilities. The equipment sets may also be connected as a 6- or 12-, 24-channel radio repeater.

Typical applications of the AN/MRC-115(V) are similar to the AN/MRC-127 shown in figure 6-4.

b. Major Characteristics.

Possible system applications:

- 6- or 12-channel pcm radio terminal ..... 2
- 6-, 12-, or 24-channel pcm radio repeater ..... 1
- Power consumption (maximum) ..... 1,500 watts
- Weight ..... 1,830 lbs



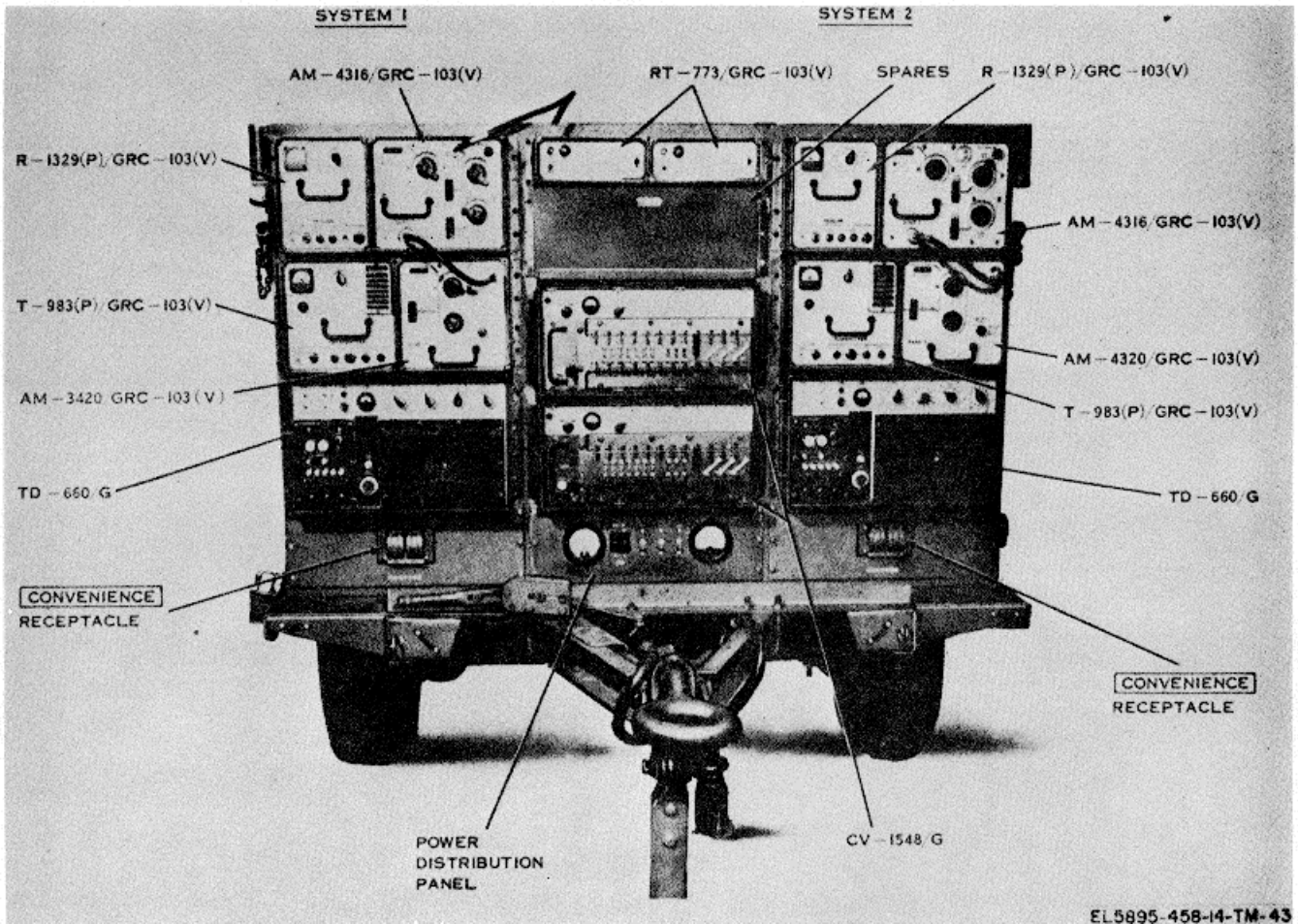

Figure 4-35. AN/MRC-115 (V) trailer, front view.

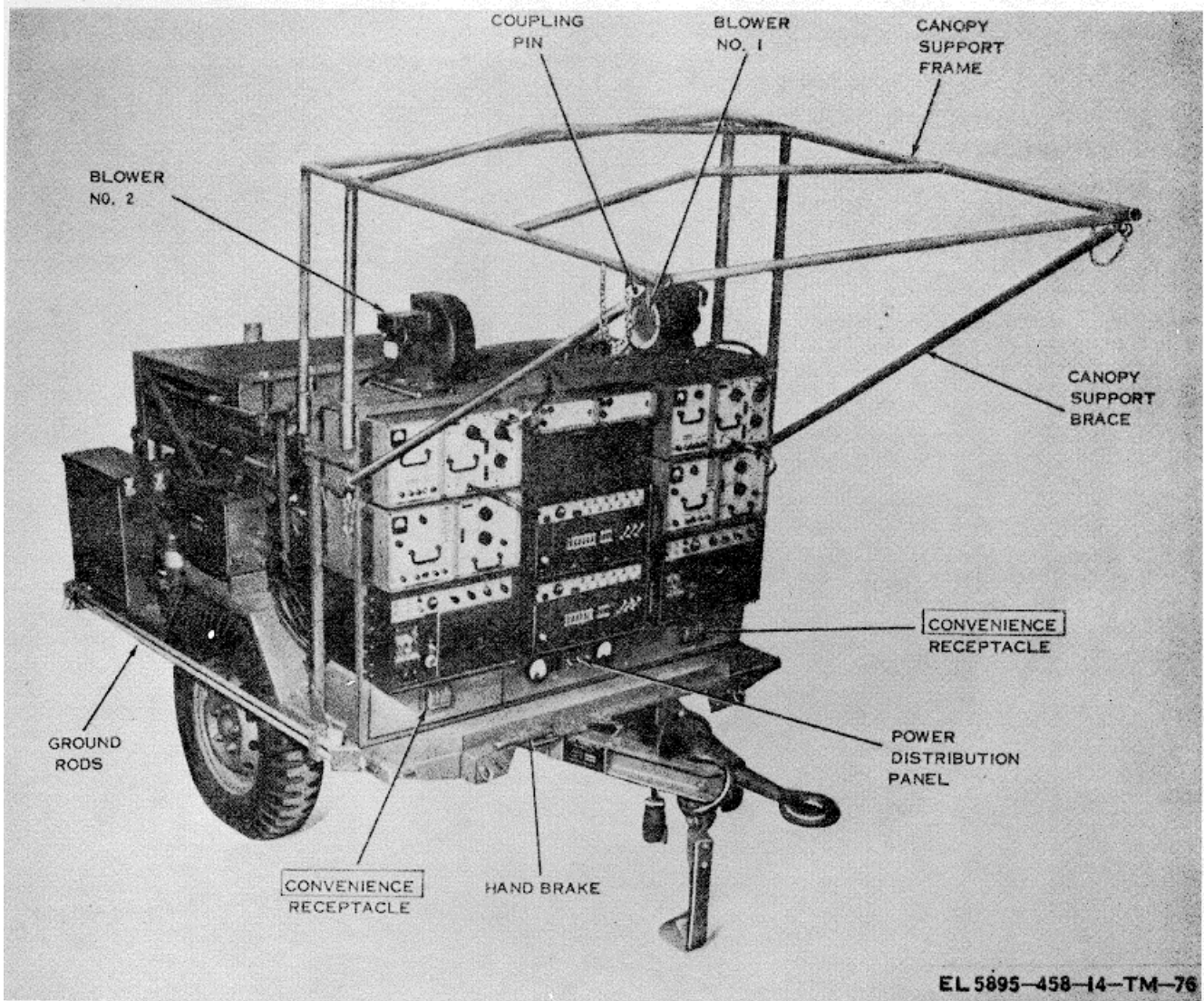

Figure 4-36. AN/MRC-115 (V) assemblage with canopy support frame erected and blowers installed.

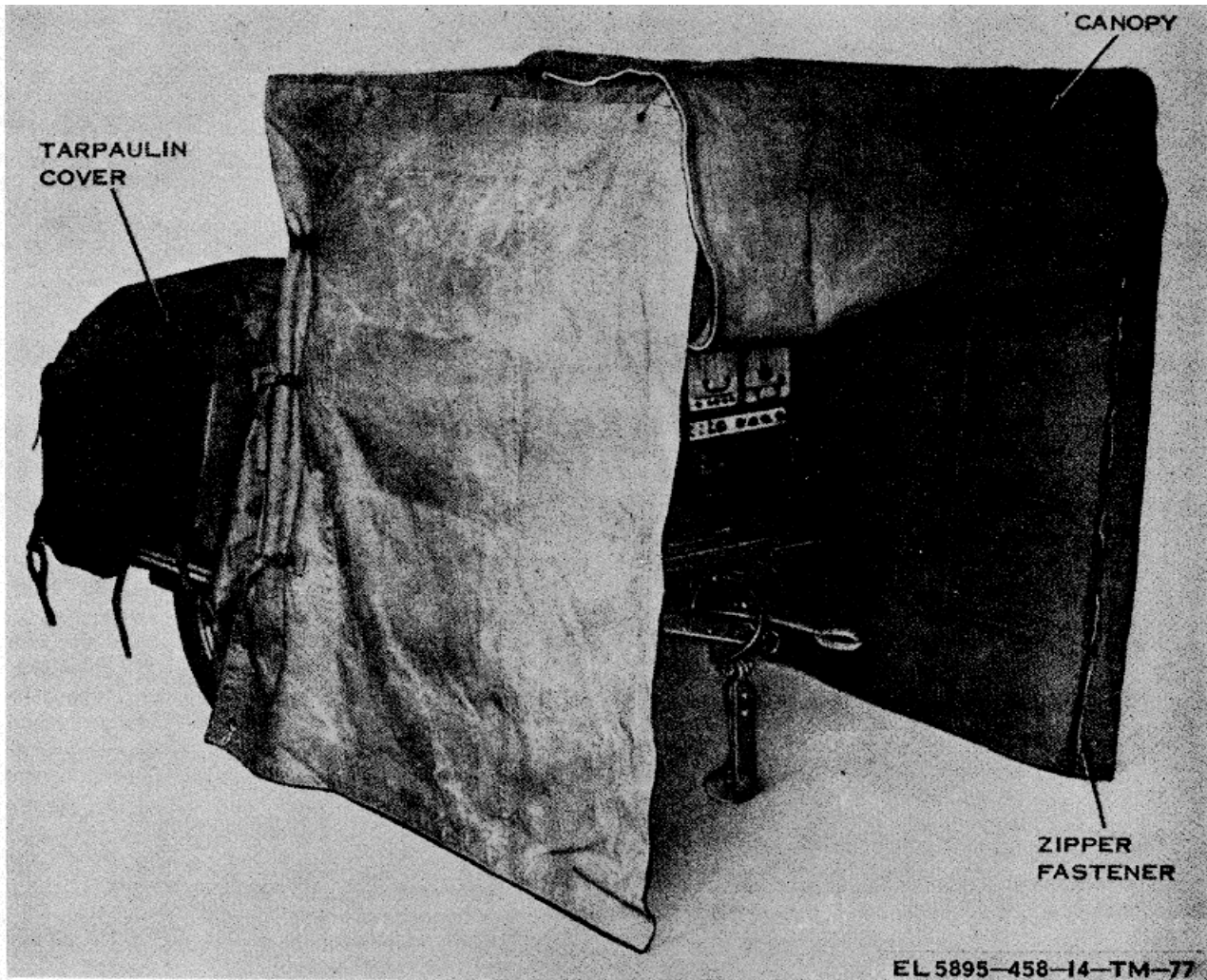

Figure 4-37. AN/MRC-115 (V) with tarpaulin in place.

**4-5. Radio Terminal Sets AN/MRC-126 and AN/MRC-127**

a. *Use.* Radio Terminal Sets AN/MRC-126 (fig. 4-9 through 4-12) and AN/MRC-127 (fig. 4-13 and 4-14) provide secure or nonsecure multiplex terminal facilities for forward area pulse code modulation (pcm) communication systems. The equipment in the AN/MRC-126 and the two equipment sets in the AN/MRC-127 can be used as a 6- or 12-channel radio terminal. Although the AN/MRC-126 and AN/MRC-127 are primarily radio terminals, the two equipment sets in the AN/MRC-127 can be used as a 12-channel radio repeater. Refer to figure 6-4 for a typical application of the AN/MRC-126 or AN/MRC-127. Interiors of the AN/MRC-126 are shown in

figures 4-38 and 4-39. Interiors of AN/MRC-127 are shown in figures 4-38 and 4-40. Figures 4-41 and 4-42 show the AN/MRC-126 or AN/MRC-127 with tarpaulin support frame raised and tarpaulin installed.

b. *Major Characteristics.*

Probable system applications:

- 6/12-channel pcm  
radio terminal ..... 2
- 12-channel pcm  
radio repeater ..... 2

Power consumption (maximum):

- AN/MRC-126 ..... 1,140 watts
- AN/MRC-127 ..... 1,630 watts

Weight:

- AN/MRC-126 ..... 1,660 lb
- AN/MRC-127 ..... 2,150 lb

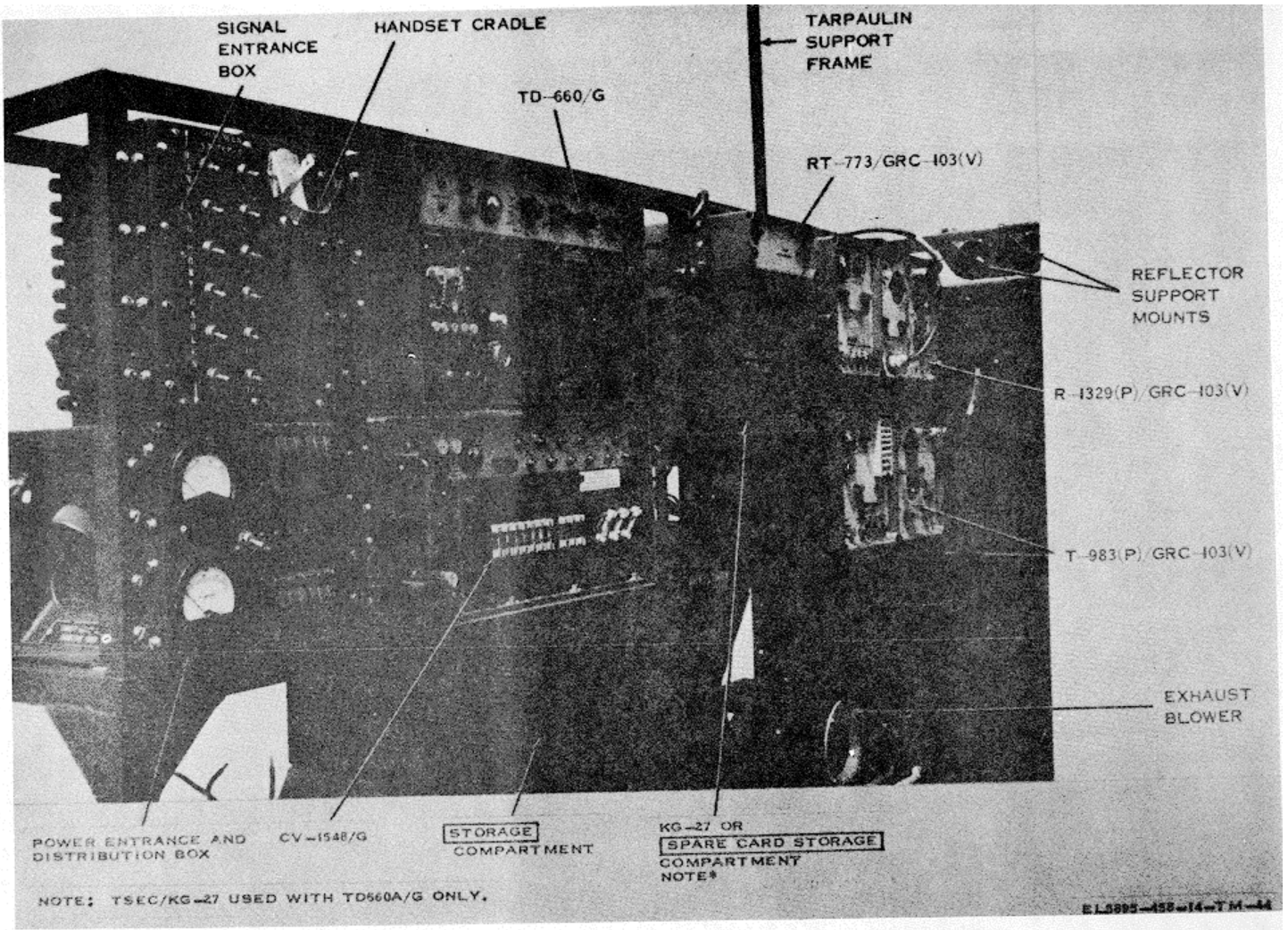

Figure 4-38. Radio Terminal Set AN/MRC-126 or AN/MRC-127, interior roadside view.



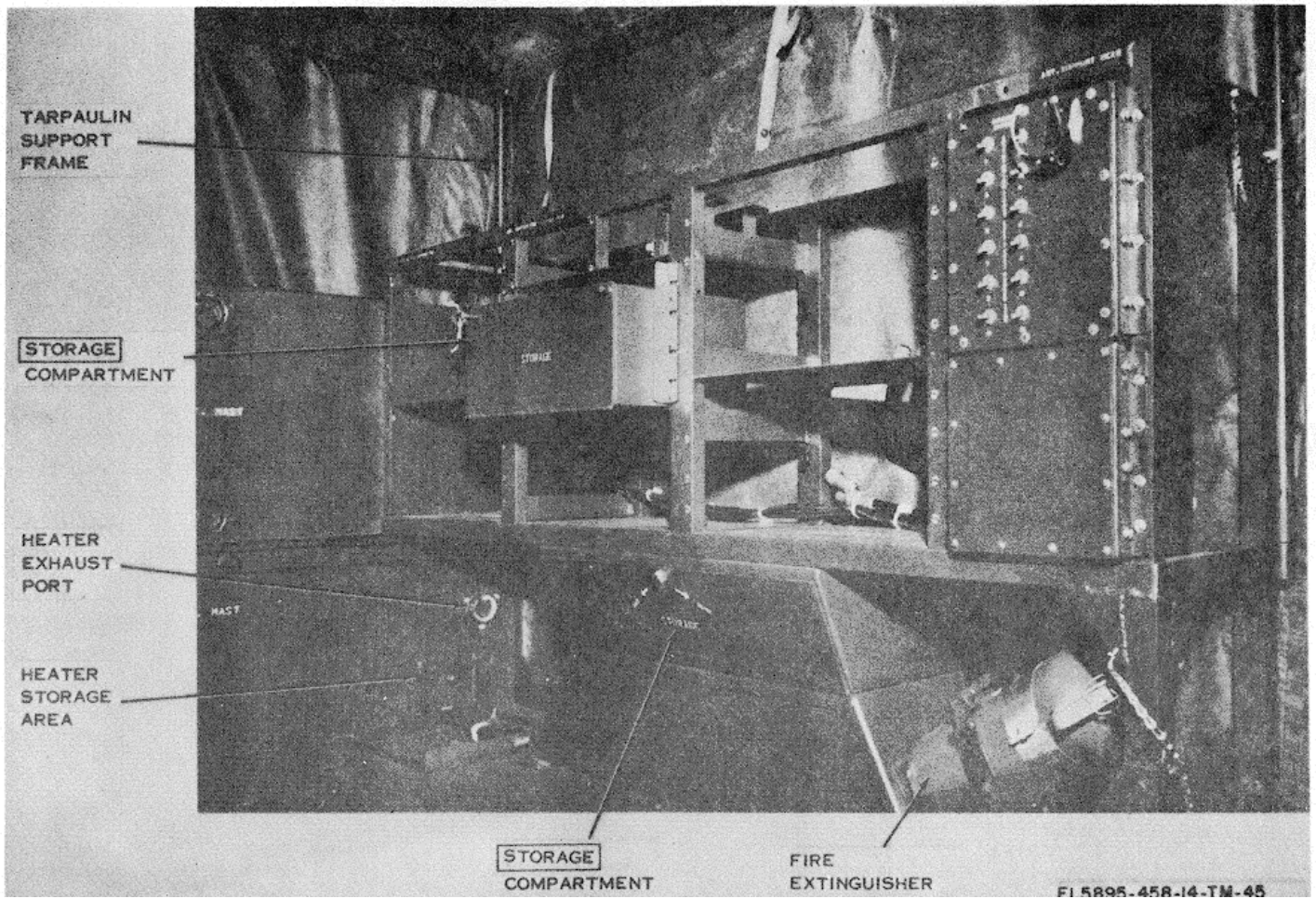

Figure 4-39. Radio Terminal Set AN/MRC-126, interior curbside view.

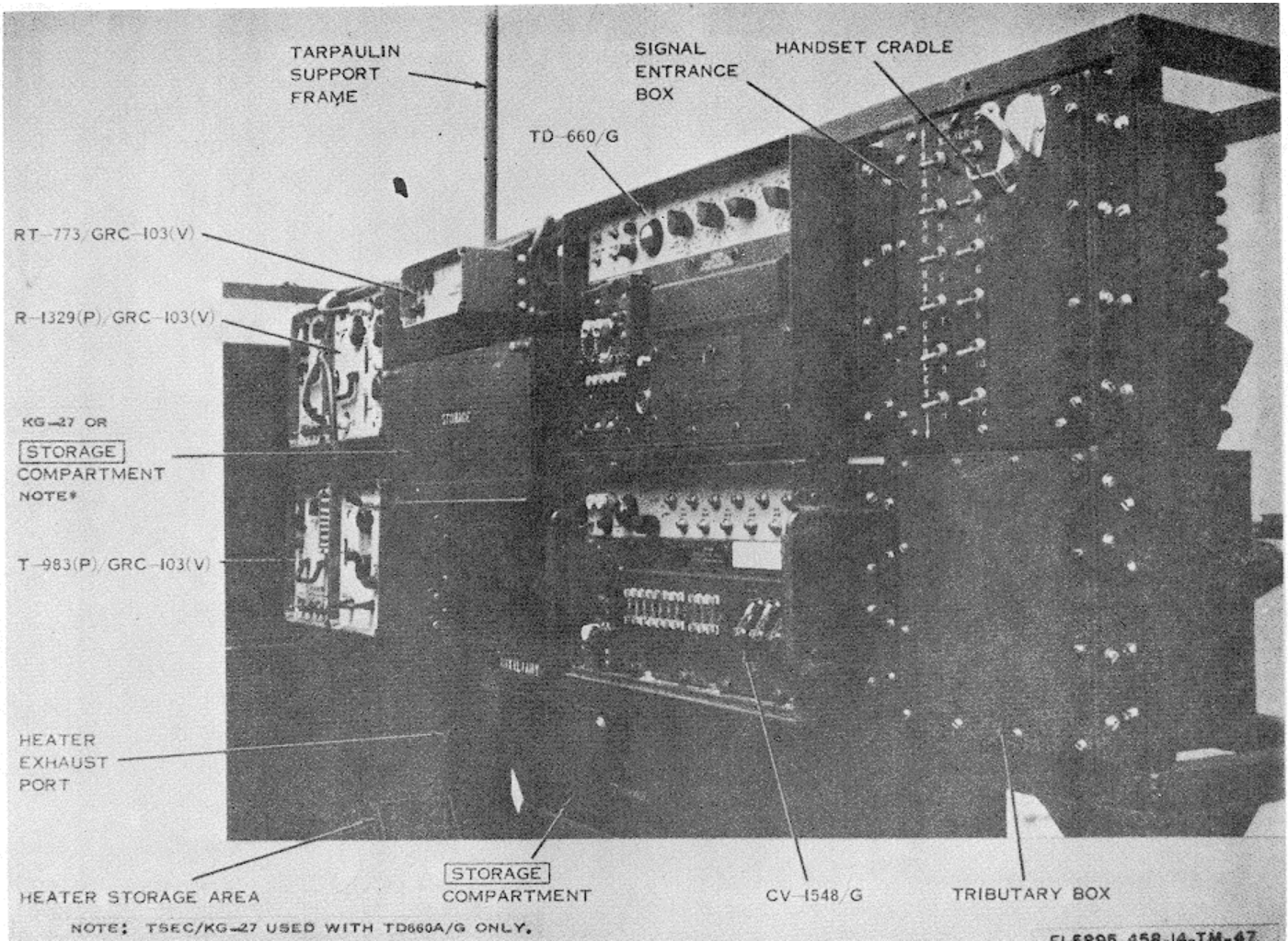

Figure 4-40. Radio Terminal Set ANIMRC-127, interior curbside view.

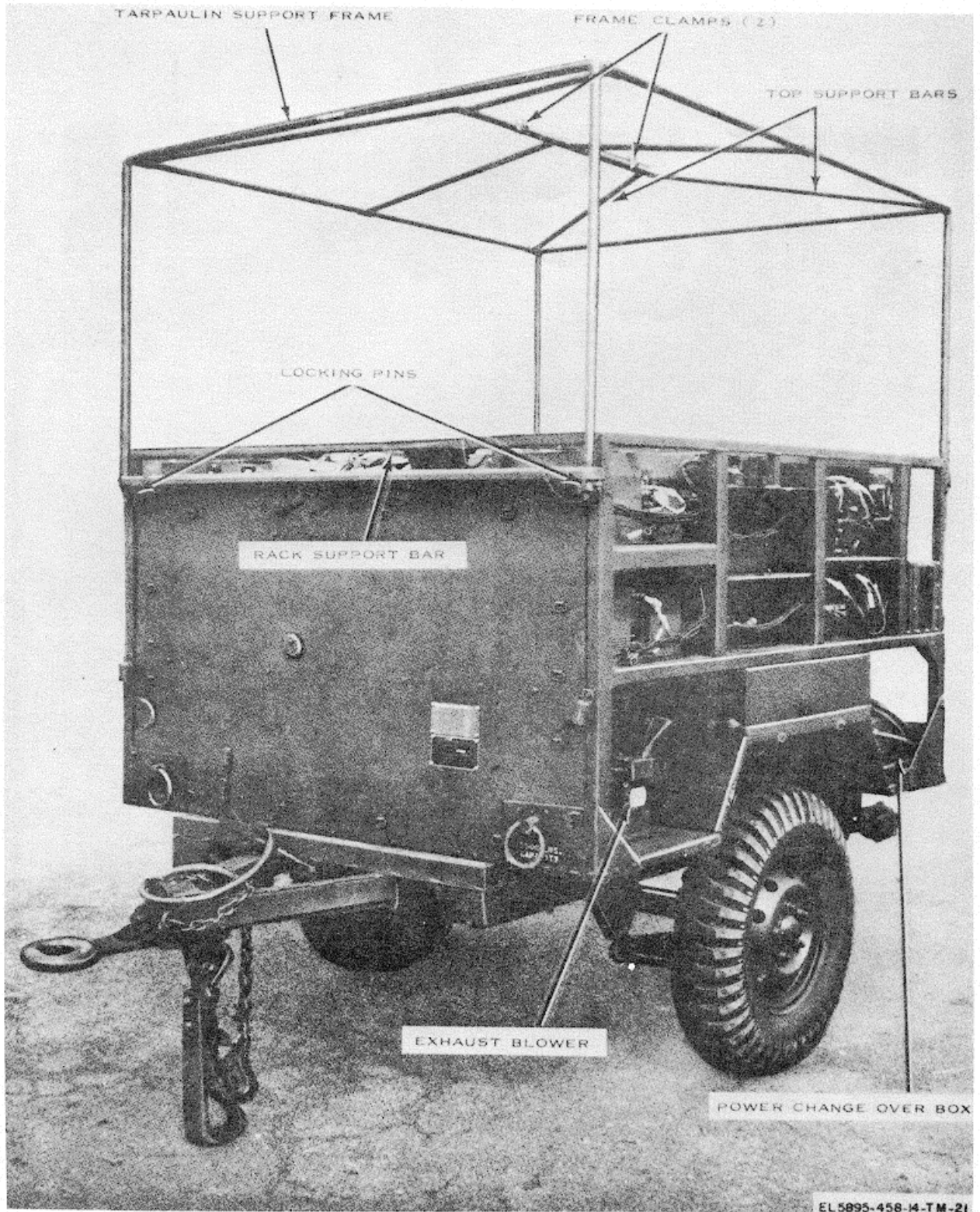

Figure 4-41. Radio Terminal Set AN/MRC-126, or AN/MRC-127, tarpaulin removed and tarpaulin support frame raised, front roadside view.

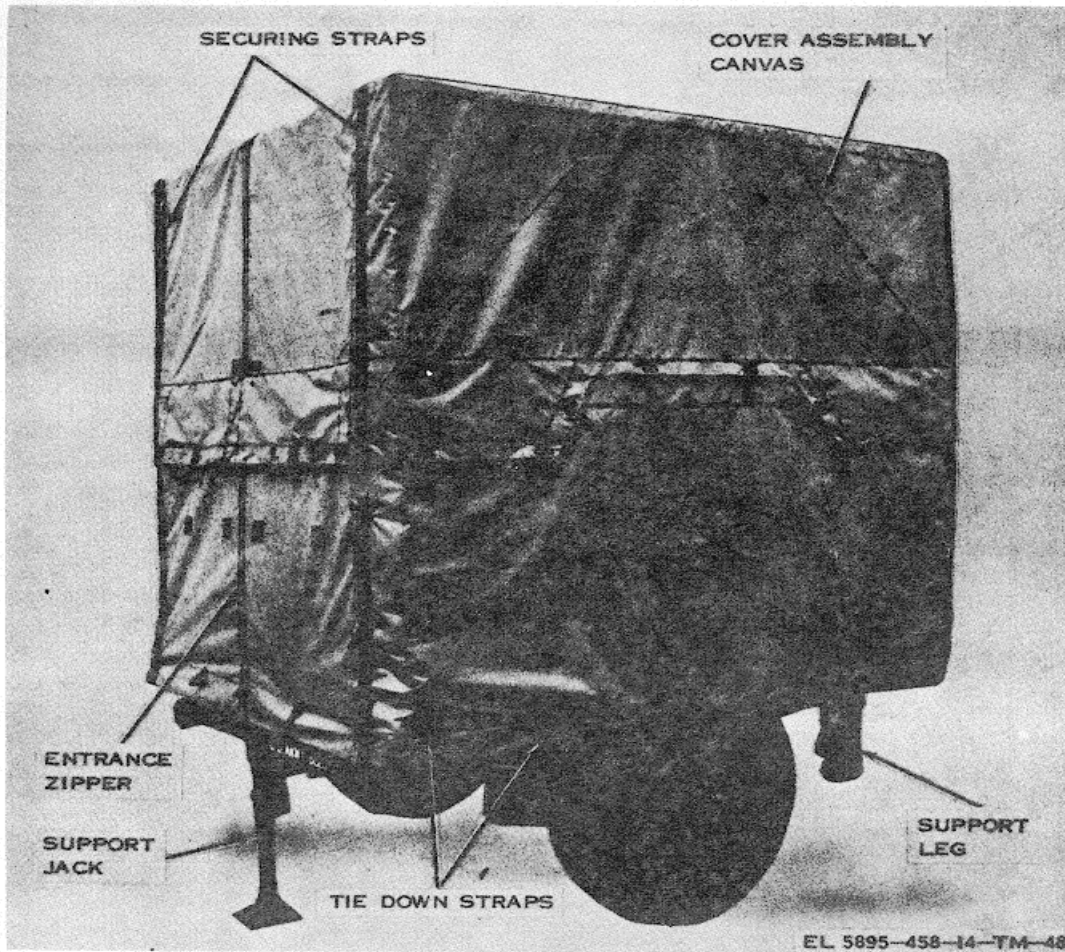

Figure 4-42. Radio Terminal Set AN/MRC-126, or AIV/MRC-127, tarpaulin installed, rear curbside view.

**4-6. Radio Terminal Set AN/TRC-145**

a. Use. Radio Terminal Set AN/TRC-145 (fig. -16 through 4-19) provides secure or non secure multiplex radio or cable terminal facilities for pulse-code-modulation (pcm) communication systems. Each of its two equipment sets provides secure or non secure 6- or 12-channel radio or cable terminal communications. Both sets can provide a secure or non secure 24-channel cable terminal facility, or a 6-, 12-, 24-, or 48-channel cable repeater facility. The two sets can be employed as a 24-channel cable repeater with 6- or 12-channel secure or non secure drop and insert facility. They can be configured for a 12- or 24-channel radio repeater facility. Each set can be utilized in 12- channel cable to radio applications. Typical applications of the AN/TRC-145 are shown in figure 6-5. Interiors of the AN/TRC-145 are shown in figures 4-43 through 4-52.

b. Major Characteristics.

Possible system applications:

6- or 12-channel pcm radio terminal .....	2
6- or 12-channel pcm cable terminal.....	2
24-channel pcm cable terminal .....	1
6-, 12-, 24-, or 48-channel pcm cable repeater .....	1
24-channel pcm cable repeater with 6- or 12-channel drop and insert .....	1
12- or 24-channel pcm radio repeater.....	1
12-channel pcm cable to radio conversion.....	2
Power consumption (maximum) .....	3,318 watts
Weight.....	2,150 lb.



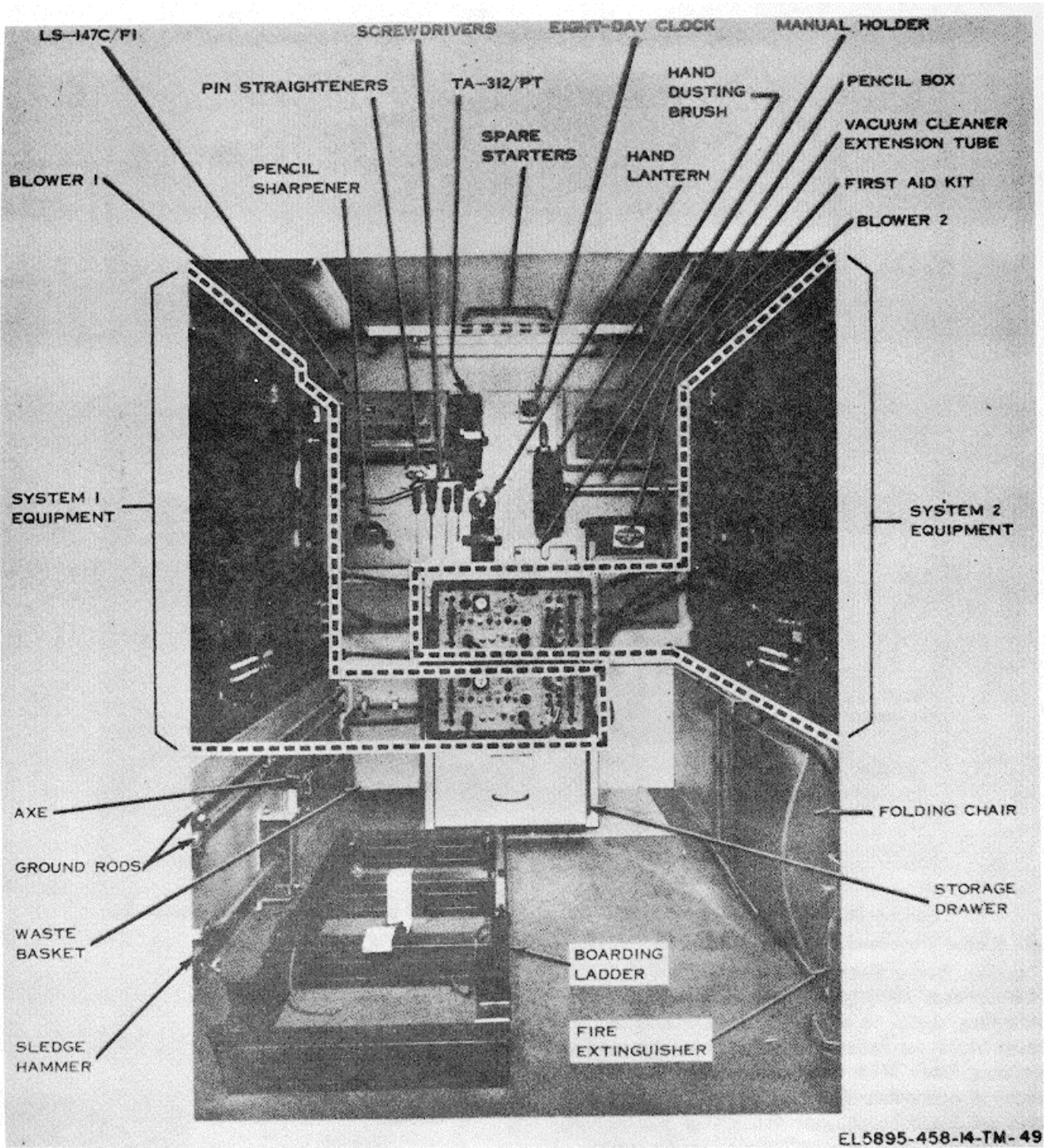

EL5895-458-14-TM-49

Figure 4-43. Radio Terminal Set AN/TRC-145 (serial No. 1 through 46), interior front view.

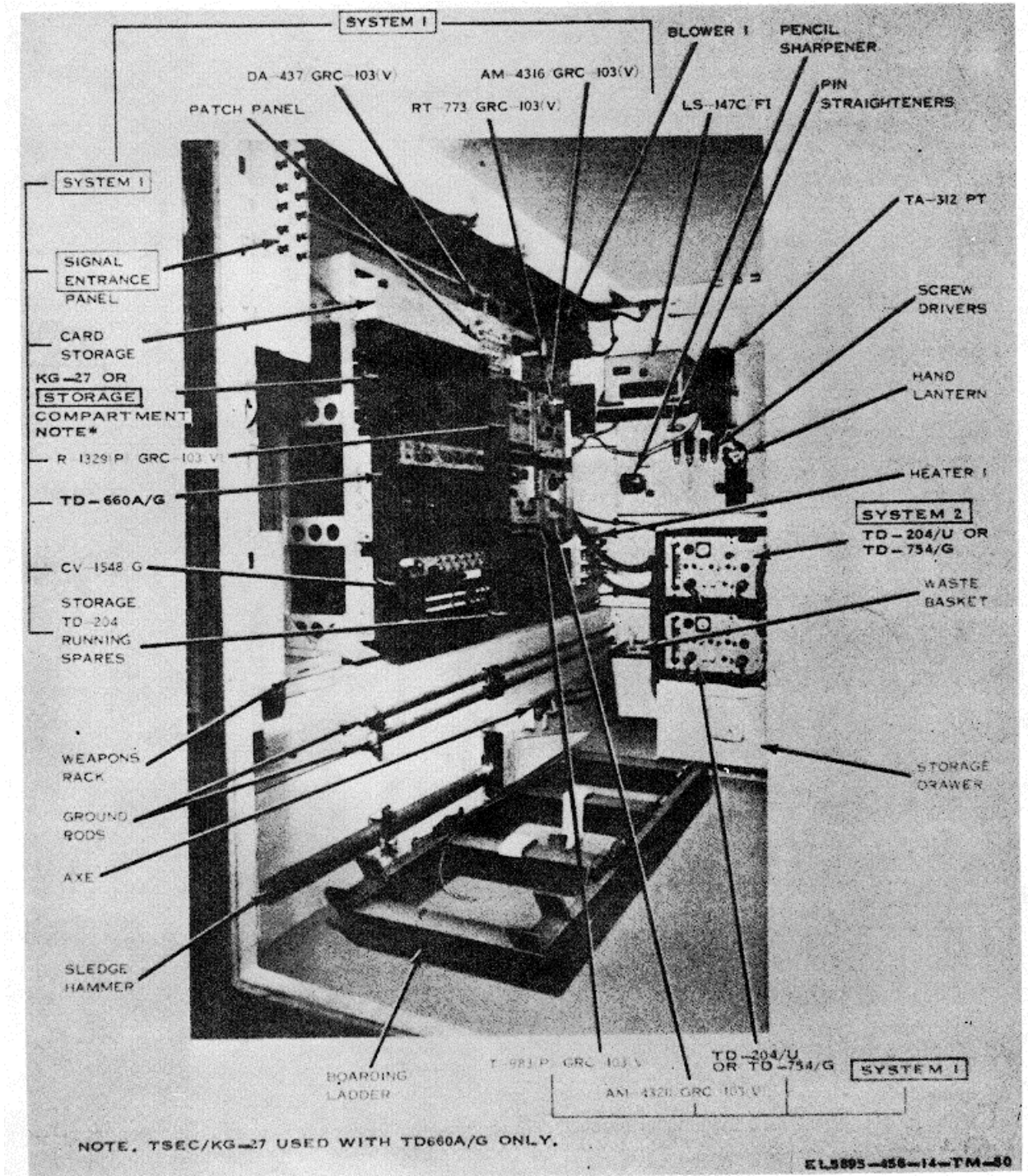

Figure 4-44. Radio Terminal Set AN/TRC-145 (serial No.1 through 46), interior front roadside view.

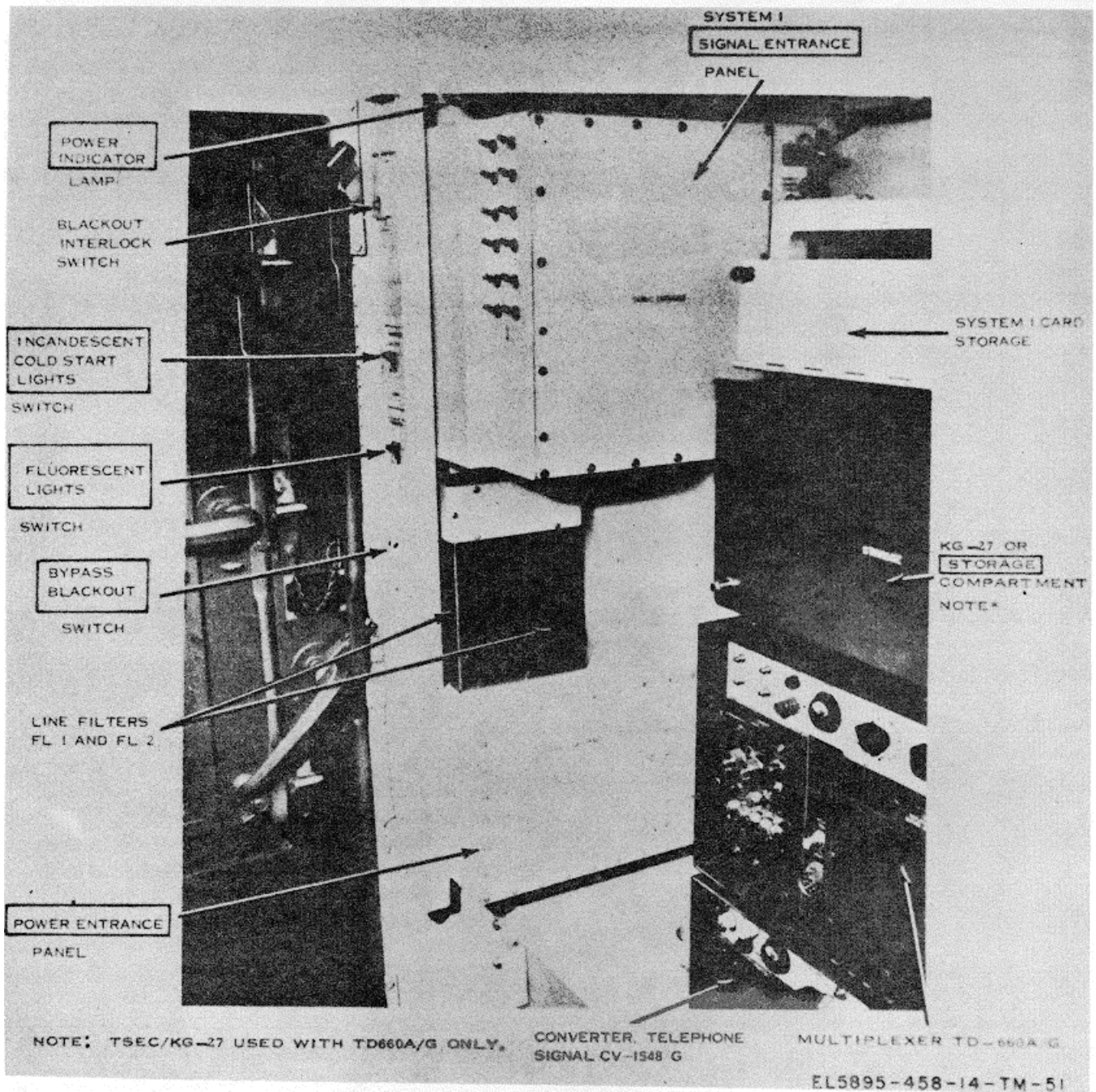

Figure 4-45. Radio Terminal Set AN/TRC-145 (serial No. 1 through 46), interior rear roadside view.



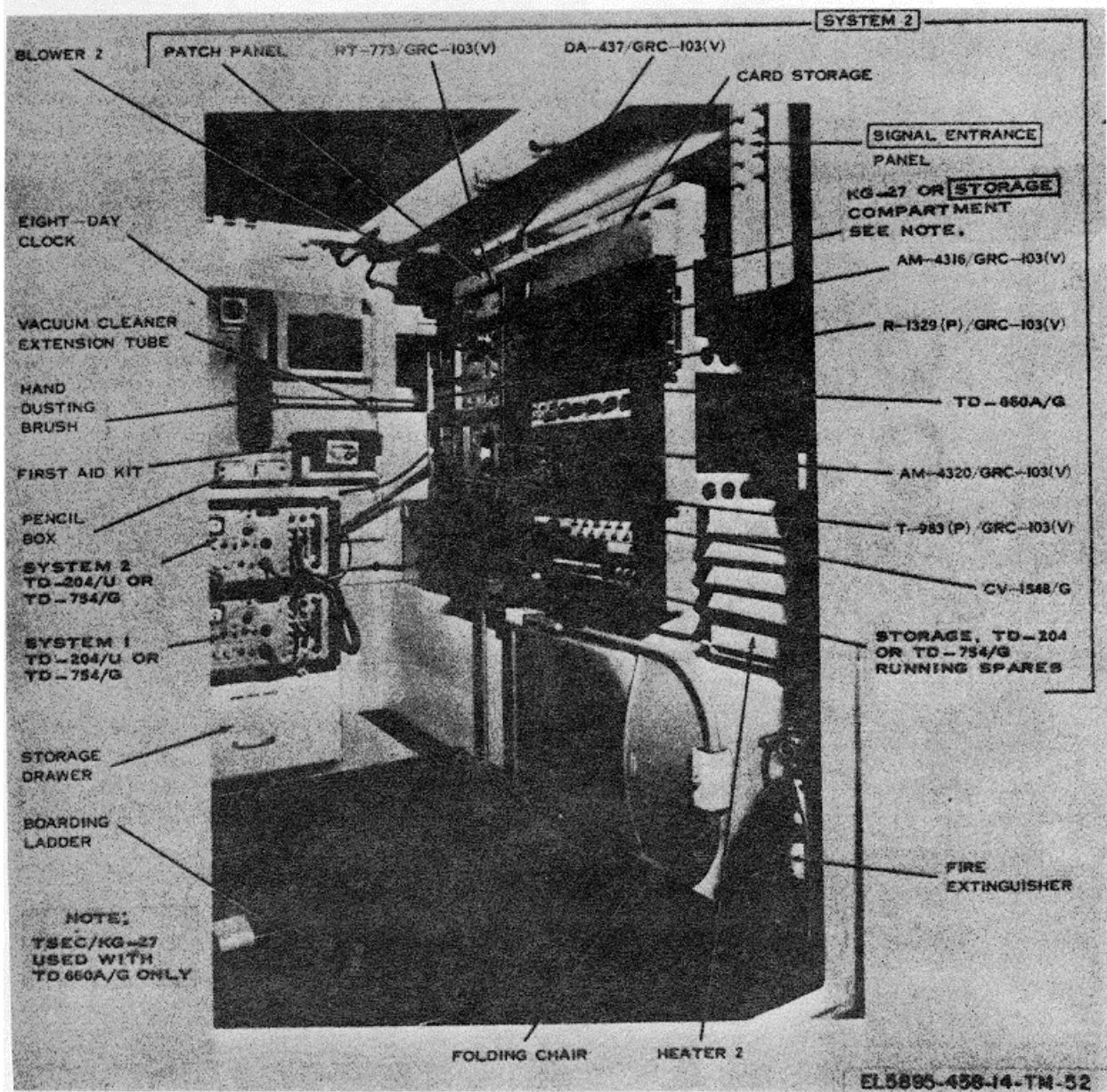

Figure 4-46. Radio Terminal Set AN/TRC-145 (serial No. 1 through 46), interior front curbside view.



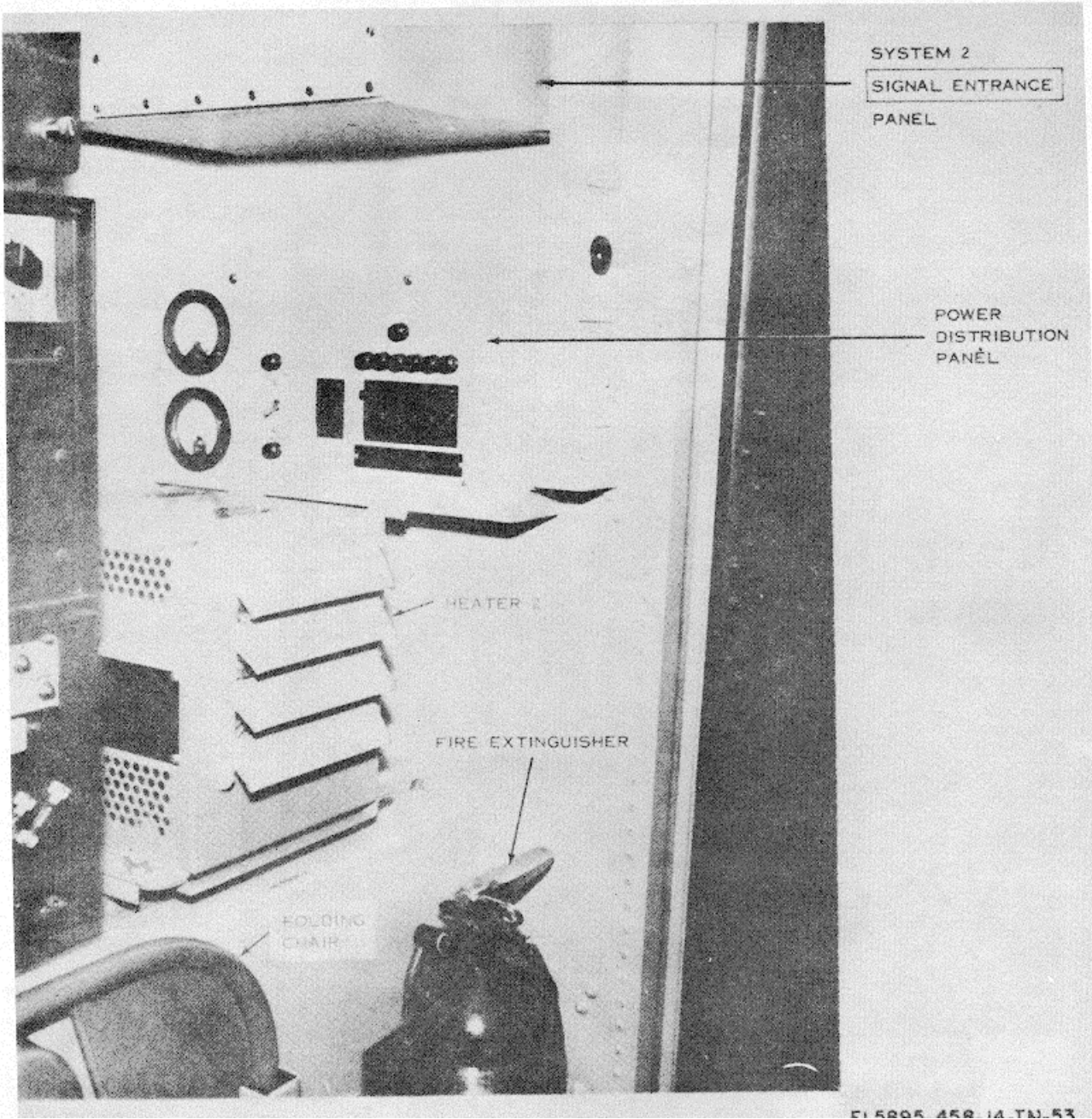

Figure 4-47. Radio Terminal Set AN/TRC-145 (serial No. 1 through 46 ), interior rear curbside view.

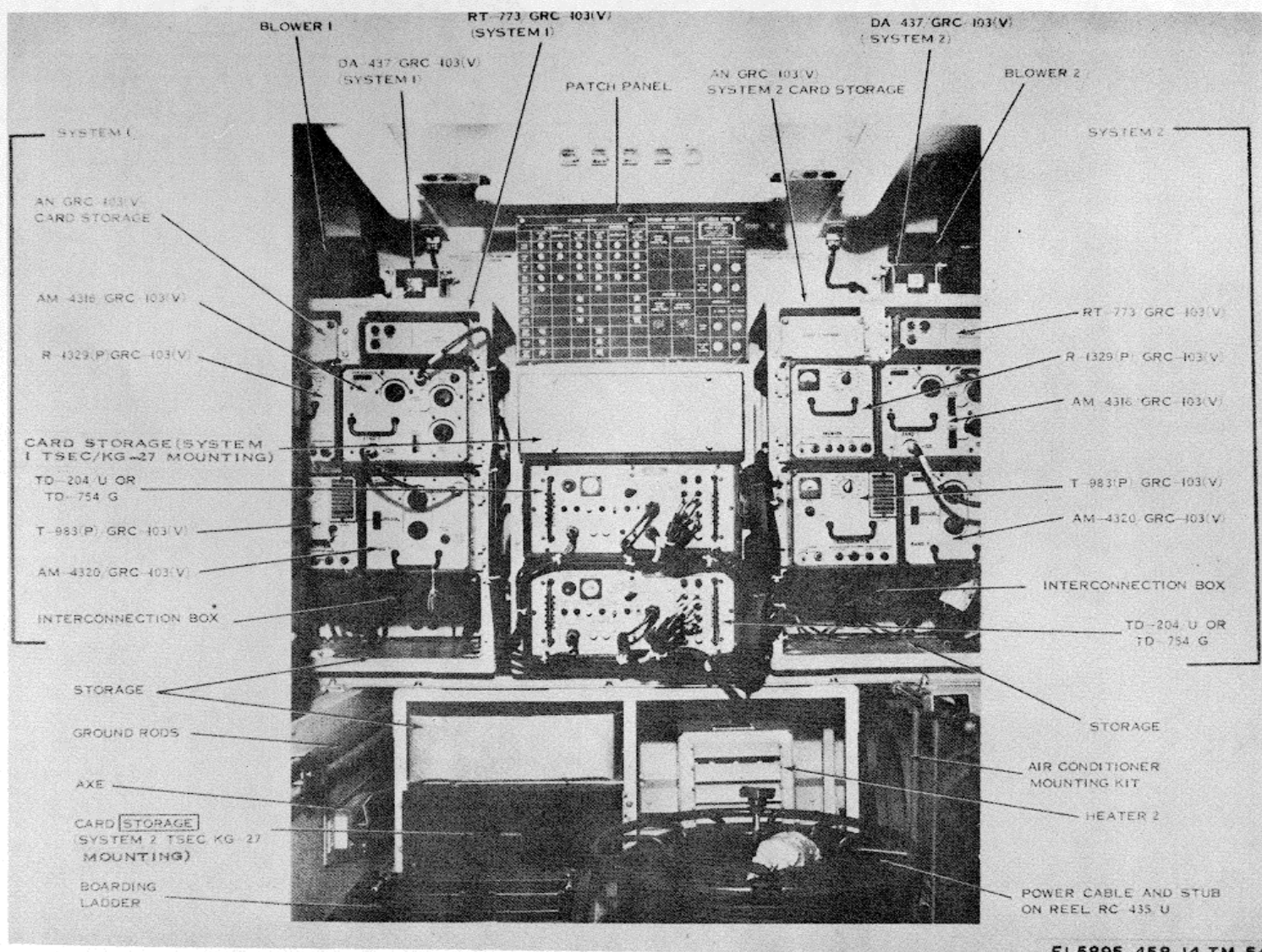

Figure 4-48. Radio Terminal Set AN/TRC-145 (serial No. 47 and above), interior front view

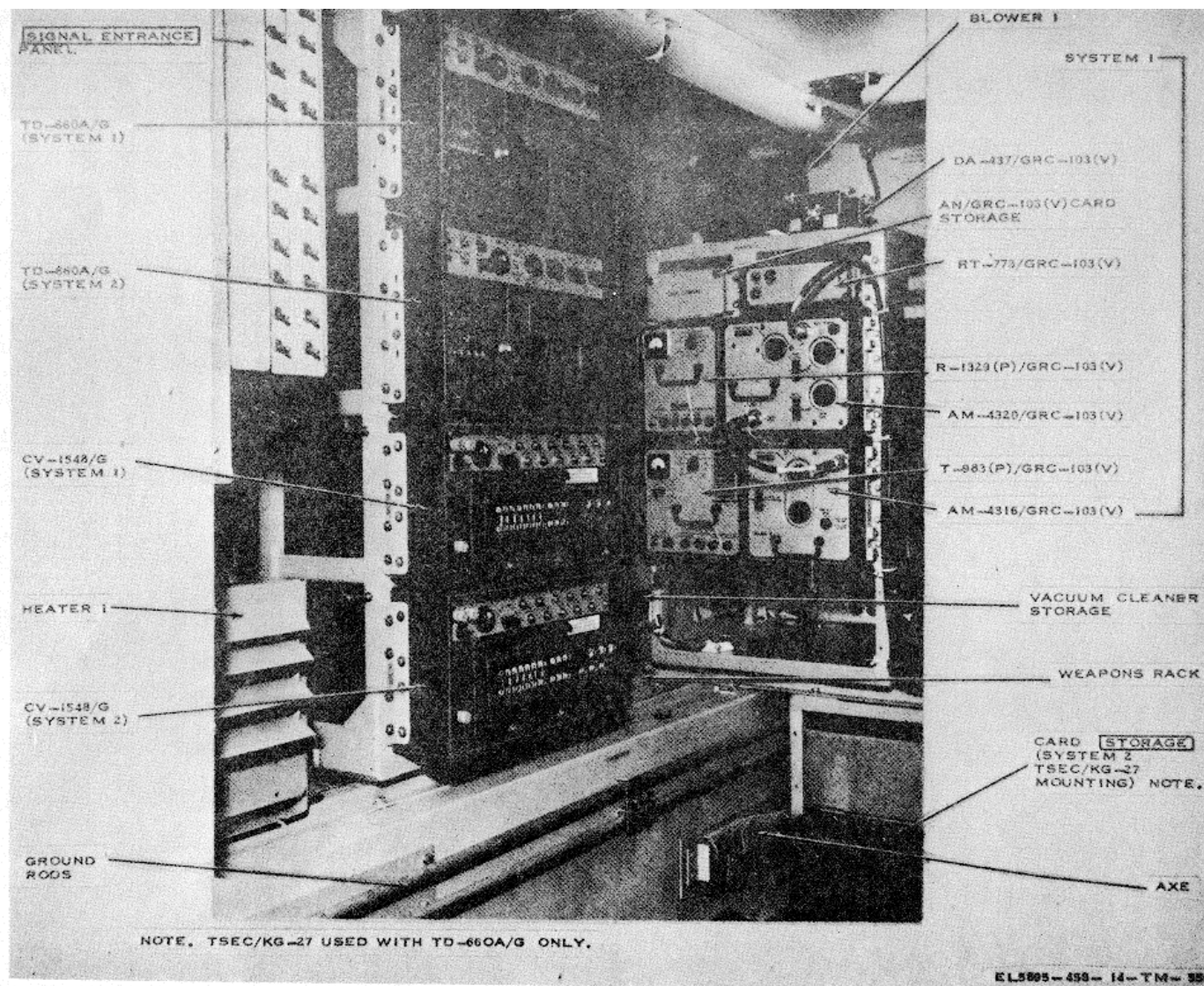

Figure 4-49. Radio Terminal Set AN/TRC-145 (serial No. 47 and above), interior front roadside view



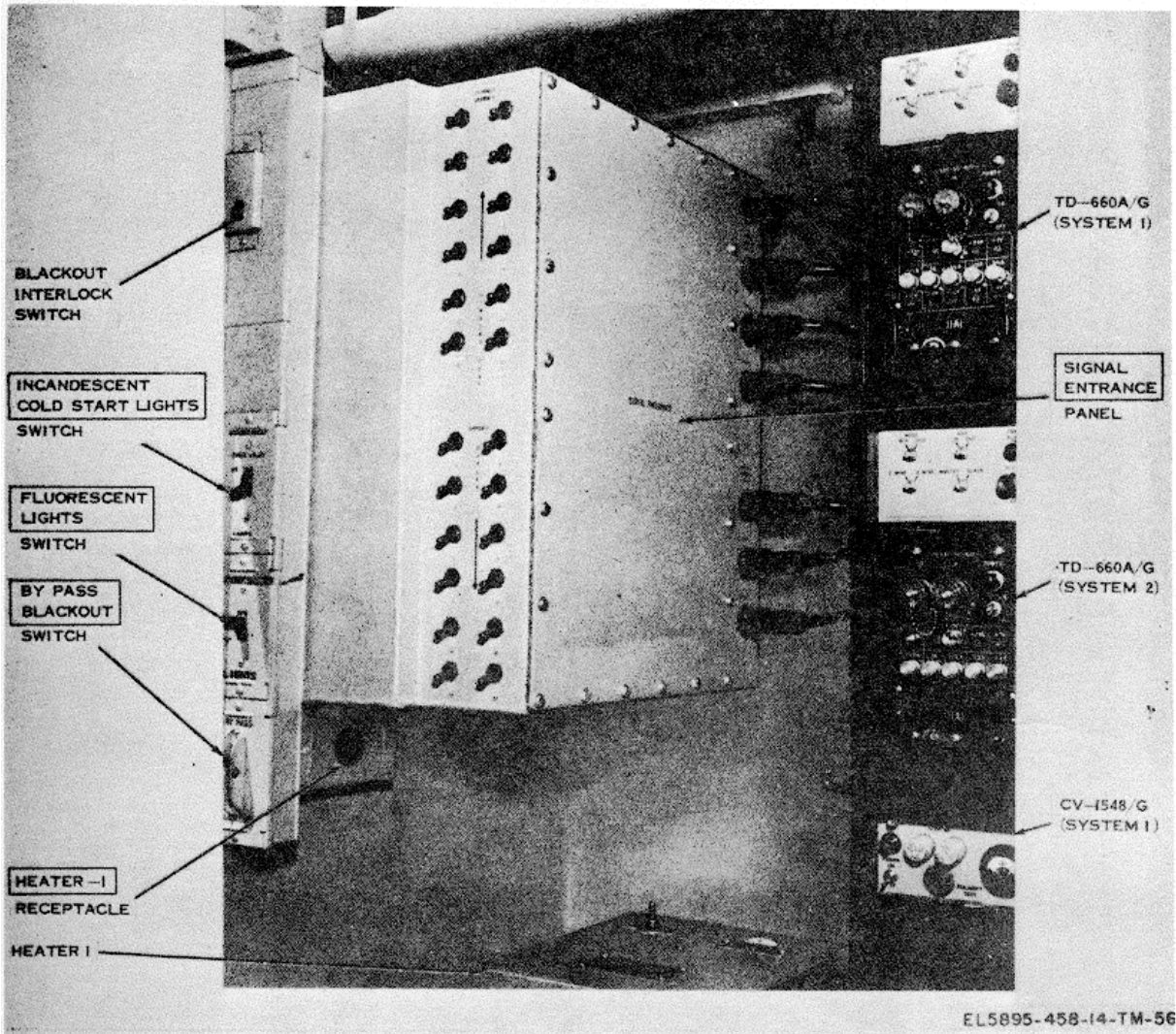

Figure 4-50. Radio Terminal Set AN/TRC-145 (serial No. 47 and above), interior rear roadside view



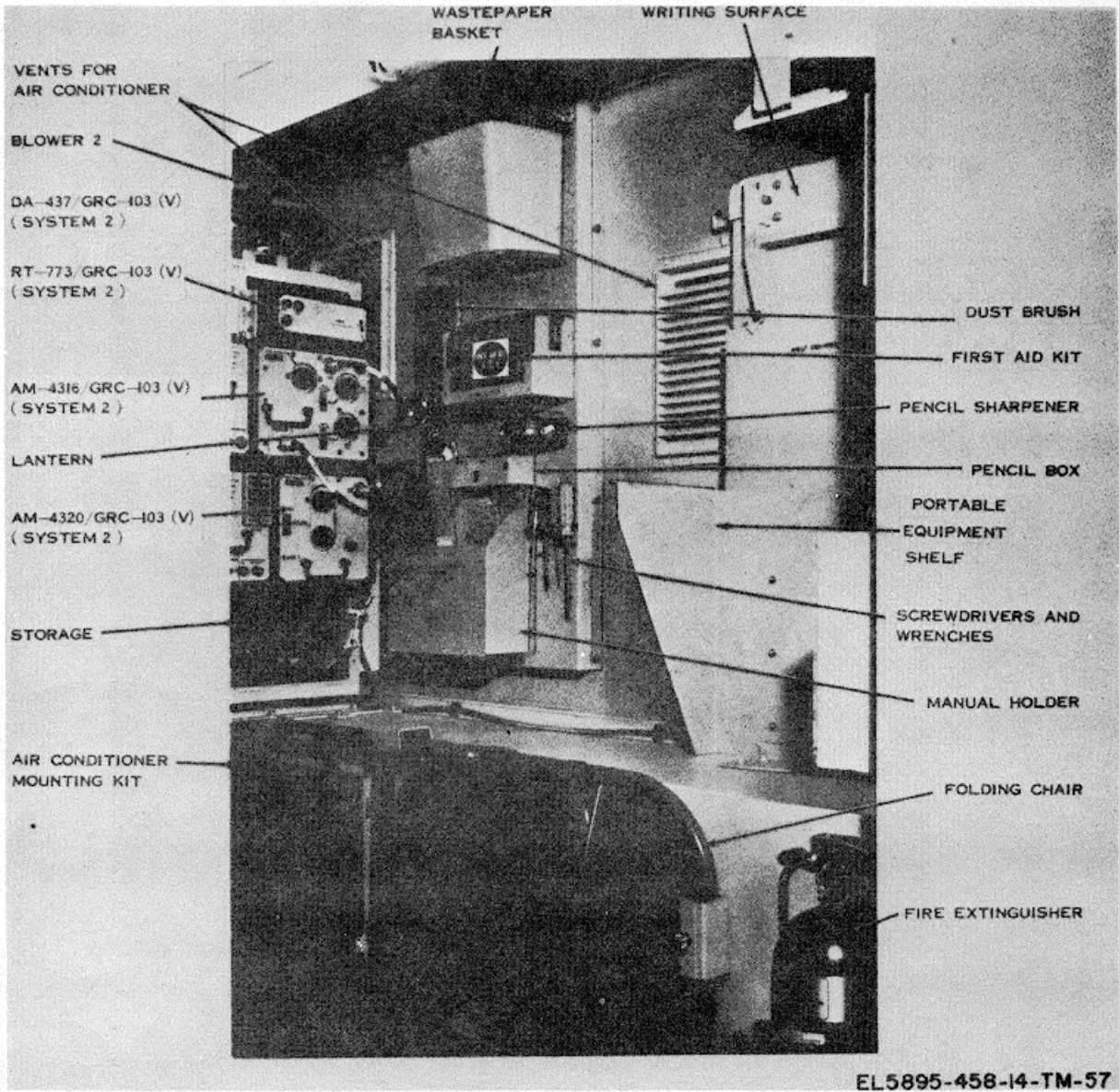

Figure 4-51. Radio Terminal Set AN/TRC-145 (serial No. And above), interior front curbside view.

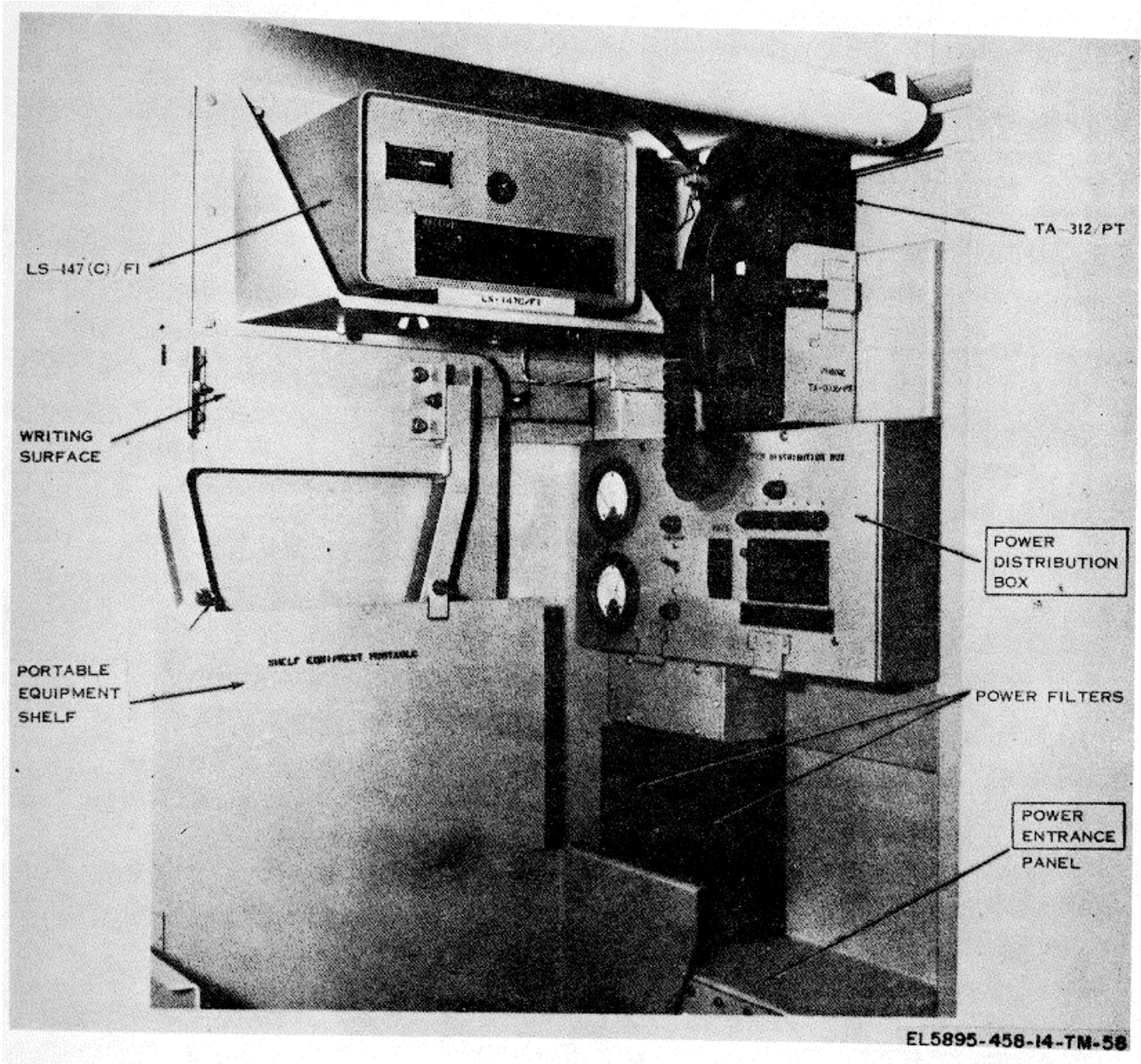

Figure 4-52. Radio Terminal Set AN/TRC-145 (serial No. 47 and above), interior rear curbside view.

## CHAPTER 5

## ASSEMBLAGE CAPABILITIES

**5-1. General**

Compatible components of the Low Capacity Tactical Radio Relay system can be arranged in varied configurations to meet specific application requirements. Block diagrams of typical 6-or12-channel pcm multiplex systems are shown in figure 5-1. Each assemblage in the system contains matched quantities of components (table 6-1) to permit optimum versatility and meet requirements for any practicable 6/12 channel pcm system. The capabilities of each assemblage are indicated in paragraphs 5-2 through 5-6.

**5-2. Terminal Set, Telephone AN/TCC-65**

The four equipment sets of the AN/TCC-65 can be employed in a combination of capabilities as indicated below:

a. Each equipment set of the AN/TCC-65 can be utilized to provide 12-channel cable transmission as shown in figure 5-2.

b. As shown in figure 5-3, any two of the four equipment sets can be configured to meet the requirements of a 12-channel cable repeater facility in a low capacity radio relay system.

**5-3. Repeater Set, Radio AN/TRC-113** As illustrated in figure 5-3, both equipment sets of the AN/TRC-113 can be employed to meet 12-channel cable repeater requirements. They can be utilized as a 12-channel radio repeater, shown in (figure 5-4). Any one of the equipment sets (fig. 5-5) can be employed in a 12-channel pcm cable to radio conversion. Although primarily a radio or cable repeater, the AN/TRC-113 can be used with other equipment, such as Terminal, Telephone AN/TCC-65 for radio terminal applications.

**5-4. Radio Terminal Set AN/MRC-115(V)** Each of the two equipment sets in the AN/MRC-115(V) can be used as a 6-or 12-channel radio terminal with order wire facilities (fig. 5-6). Both sets can be employed as a 6-or 12-channel radio repeater with order wire facilities.

**5-5. Radio Terminal Sets AN/MRC-126 and AN/MRC-127**

As illustrated in figure 5-6, the equipment sets in the AN/MRC-126 or the AN/MRC-127 can be employed for an on secure 6-or 12-channel radio terminal, or a secure radio terminal (fig. 5-8) in a low capacity tactical radio relay system. Both equipment sets of the AN/MRC-127 can be used as a 12-channel radio repeater (fig. 5-4).

**5-6. Radio Terminal Set AN/TRC-145**

Radio Terminal Set AN/TRC-145 constitutes two equipment sets which can be arranged to provide secure or nonsecure cable or radio terminal facilities, cable or radio repeater facilities, and cable to radio conversion (fig. 5-2 through 5-8).

a. *Radio Terminal.* (1) Each equipment set can be arranged to provide a 6-or 12-channel nonsecure pcm radio terminal facility as shown in figure 5-6. (2) Each equipment set can be arranged to provide 6-or 12-channel secure pcm radio terminal facility as shown in figure 5-7.

b. *Cable Terminal.*

(1) Each equipment set can be arranged to provide a 6-or 12-channel nonsecure pcm cable terminal facility as shown in figure 5-2. (2) Each equipment set can be arranged to provide a 6-or 12-channel secure pcm cable terminal facility as shown in figure 5-8.

c. *Repeaters.*

(1) Both equipment sets of the AN/TRC-145 can be employed to meet requirements for a 6-or 12-channel pcm cable repeater as shown in figure 5-3. (2) Both equipment sets can be arranged to provide a 6-or 12-channel pcm radio repeater facility as shown in figure 5-4.

d. *Cable to Radio.* As illustrated in figure 5-5, each equipment set can be arranged to provide 12-channel pcm cable to radio conversion with order wire facility.

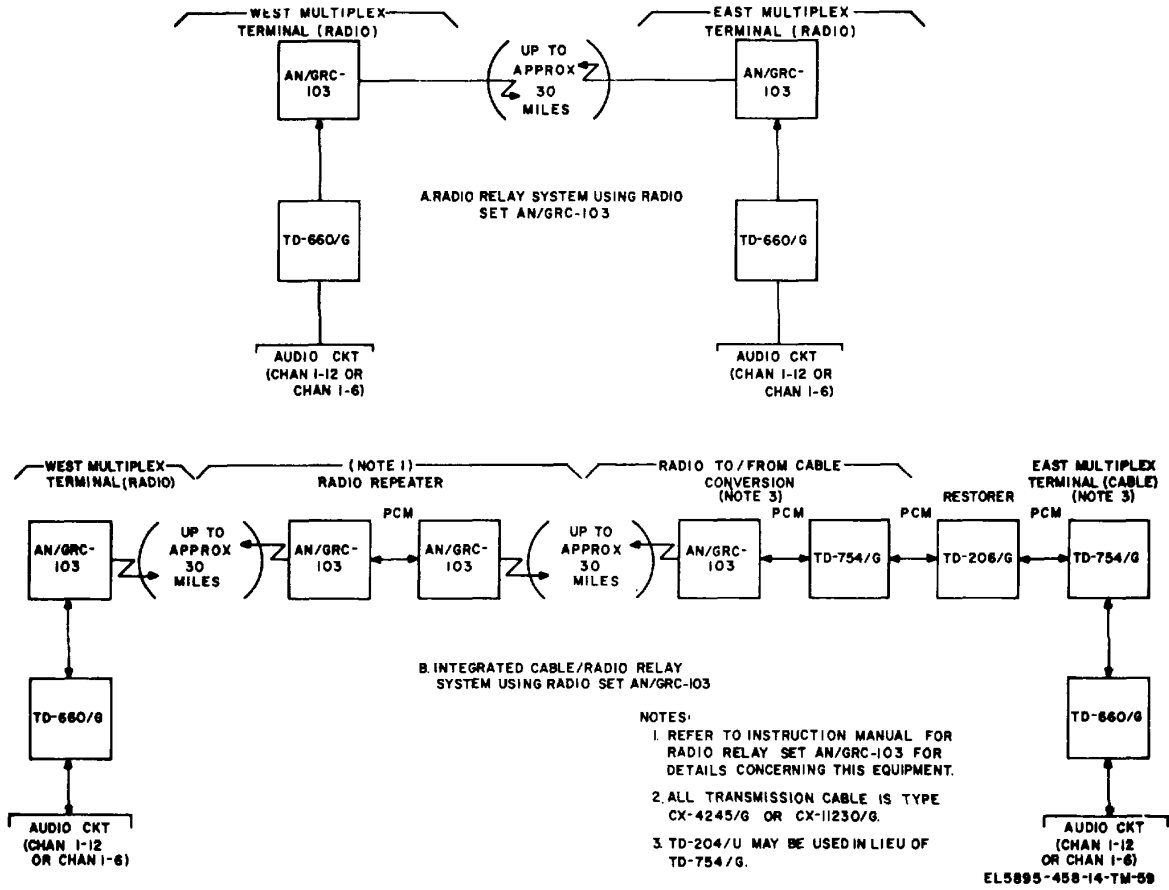

Figure 5-1. Typical 6- or 12-channel multiplex carrier systems.

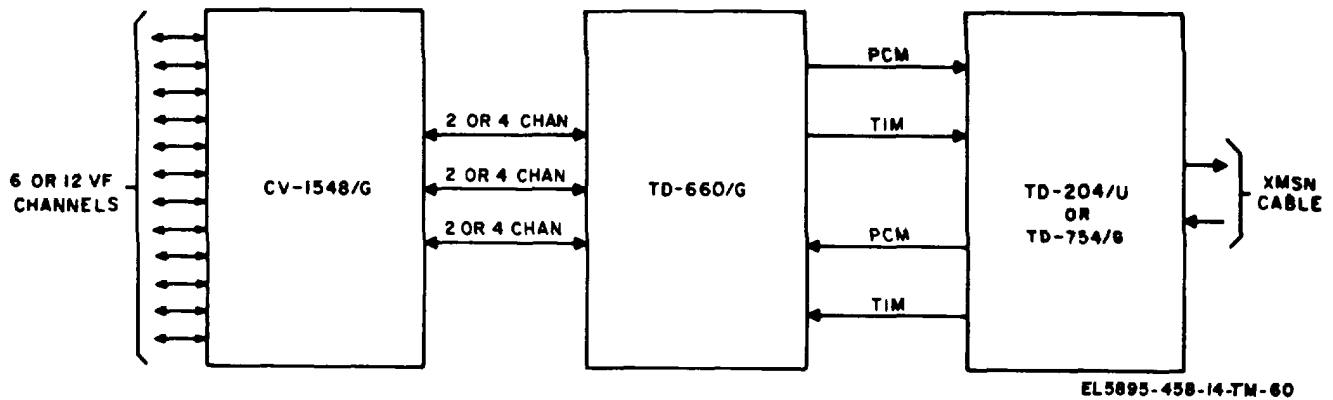

Figure 5-2. 6- or 12-channel nonsecure cable terminal application, block diagram.



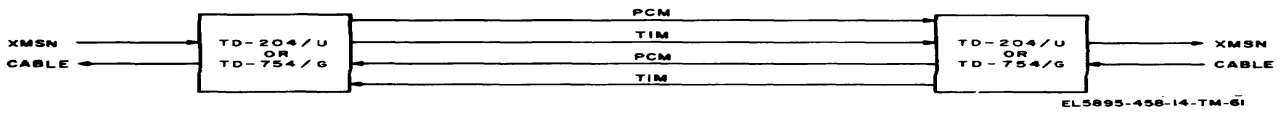

Figure 5-3. 6-, 12-, 24-, 24-, or 48-channel cable repeater application, block diagram.

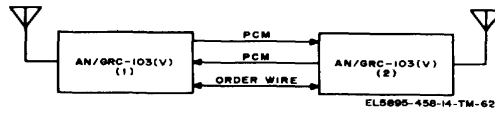

Figure 5-4. Typical 6 - or 12-channel radio repeater application, block diagram.

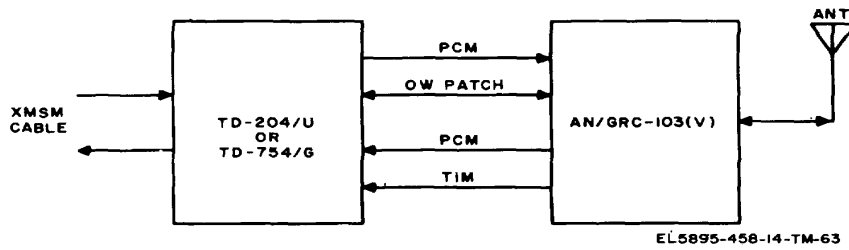

Figure 5-5. 12-channel cable-to-radio conversion application, block diagram.

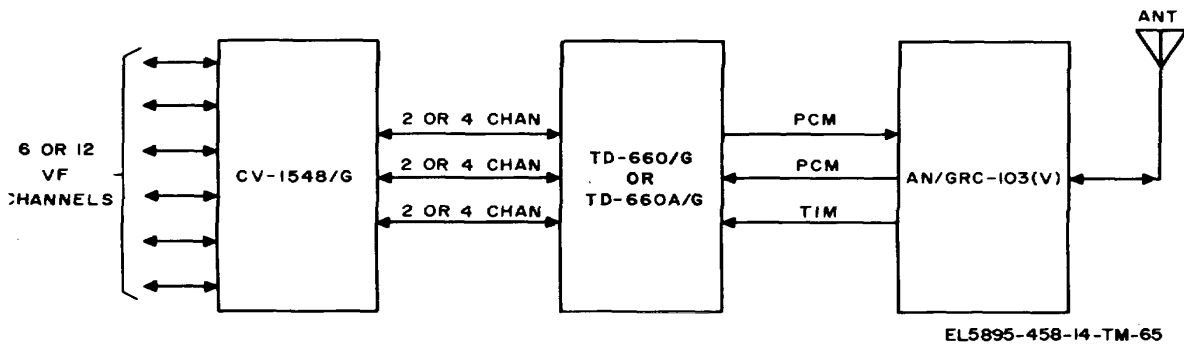

Figure 5-6. 6- or 12 channel nonsecure radio terminal application, block diagram.

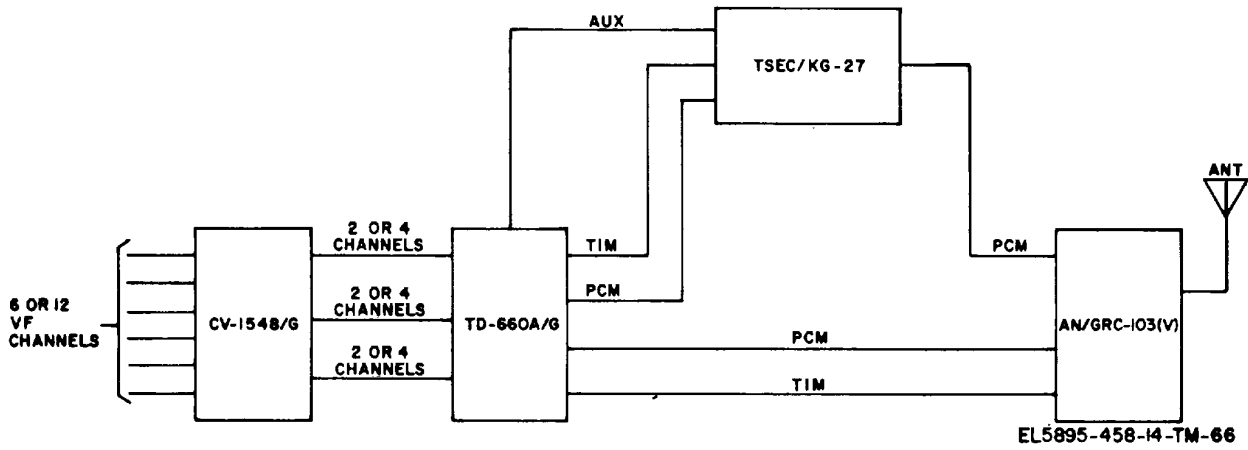

Figure 5-7. 6- or 12-channel secure radio terminal application, block diagram.

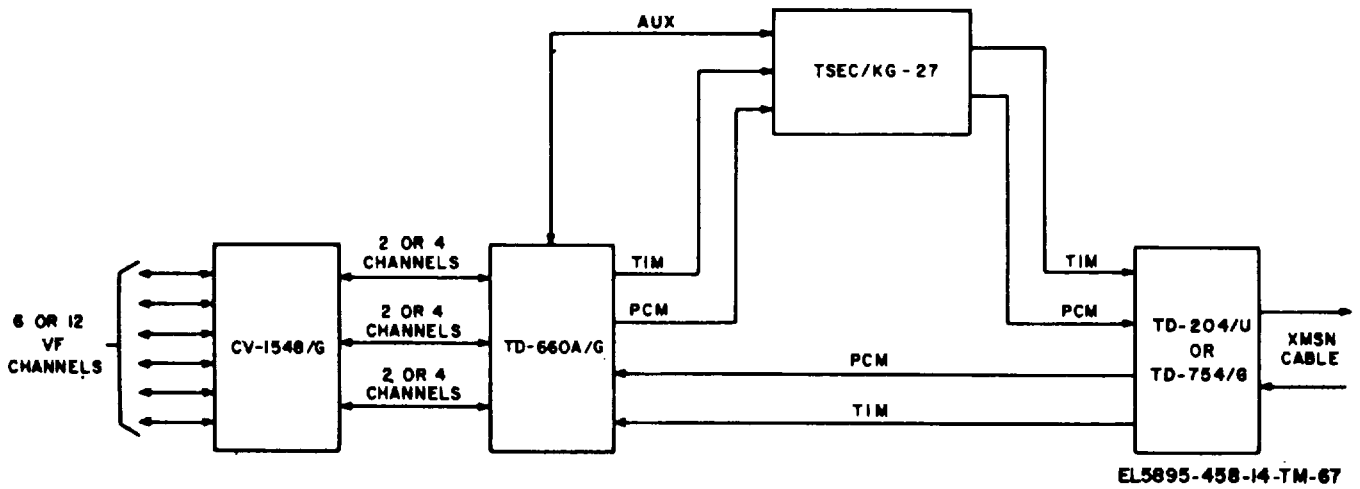

Figure 5-8. 6- or 12 channel secure cable terminal application, block diagram

## CHAPTER 6 SYSTEM DESCRIPTION AND DATA

### 6-1. Purpose-and Use

*a. Purpose.* The Low Capacity Tactical Radio Relay System provides a tactical secure or nonsecure (6/12channels) communication link. The system contains circuits capable of voice frequency (vf) transmission over radio and cable.

*b. Use.* The Low Capacity Tactical Radio Relay System provides multi channel communication systems through appropriate signal centers. These centers link major unit head quarters among division, support, avionics, and brigade units as shown in figure 6-1.

### 6-2. System Assemblages

Table 6-1 lists the assemblages, major components and their primary employment, within the Army Tactical Communication System (ATACS). Typical applications, of the assemblages, are shown in figures 6-2 through 6-5. The quantities of the listed major components are to allow for, and satisfy, the requirements of a 6/12 channel Low Capacity Tactical Radio Relay System

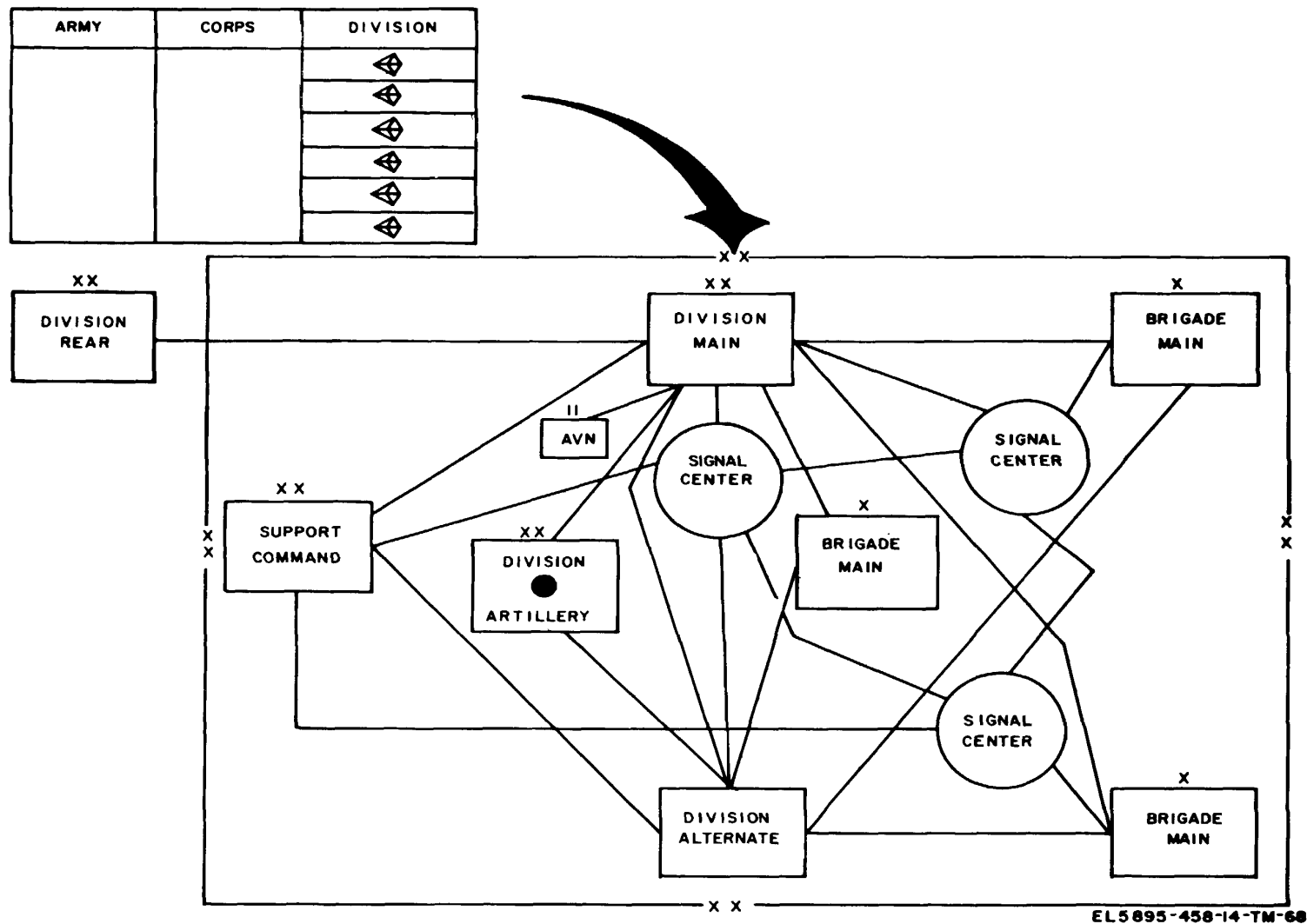
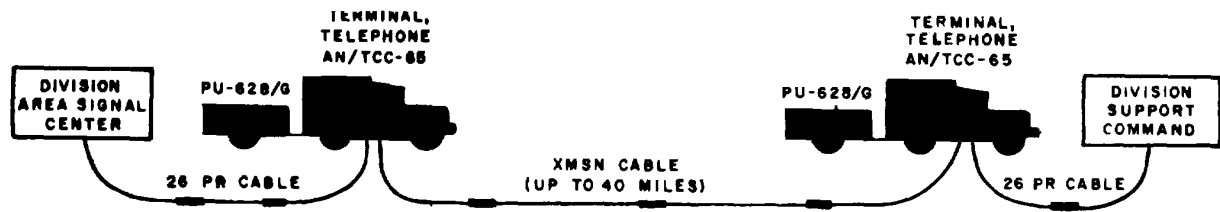
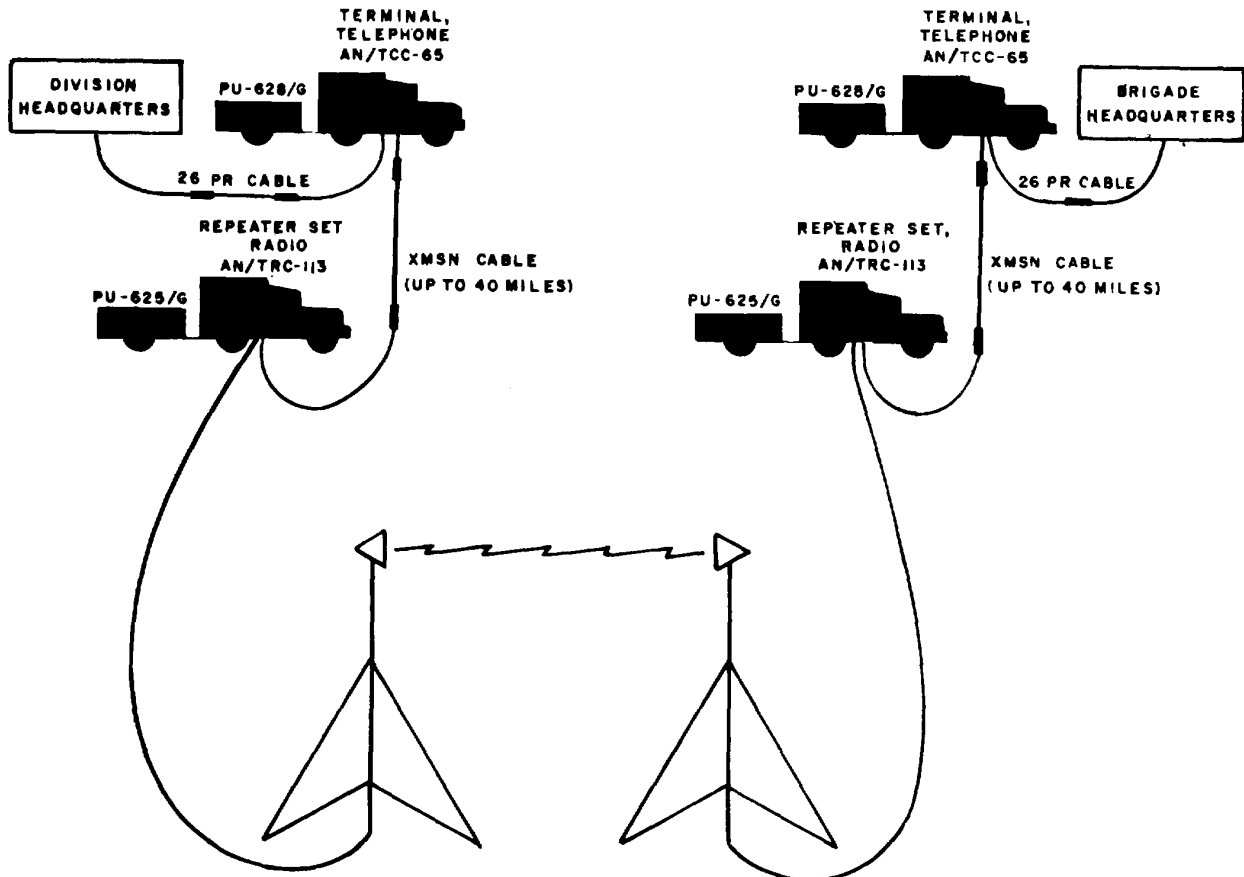

Figure 6-1. Typical employment of Low Capacity Tactical Radio Relay System in Tactical Field Army





A. CABLE SYSTEM.



B. RADIO SYSTEM.

EL5895-458-14-TM-69

Figure 6-2. Typical applications of ANM/TCC-65

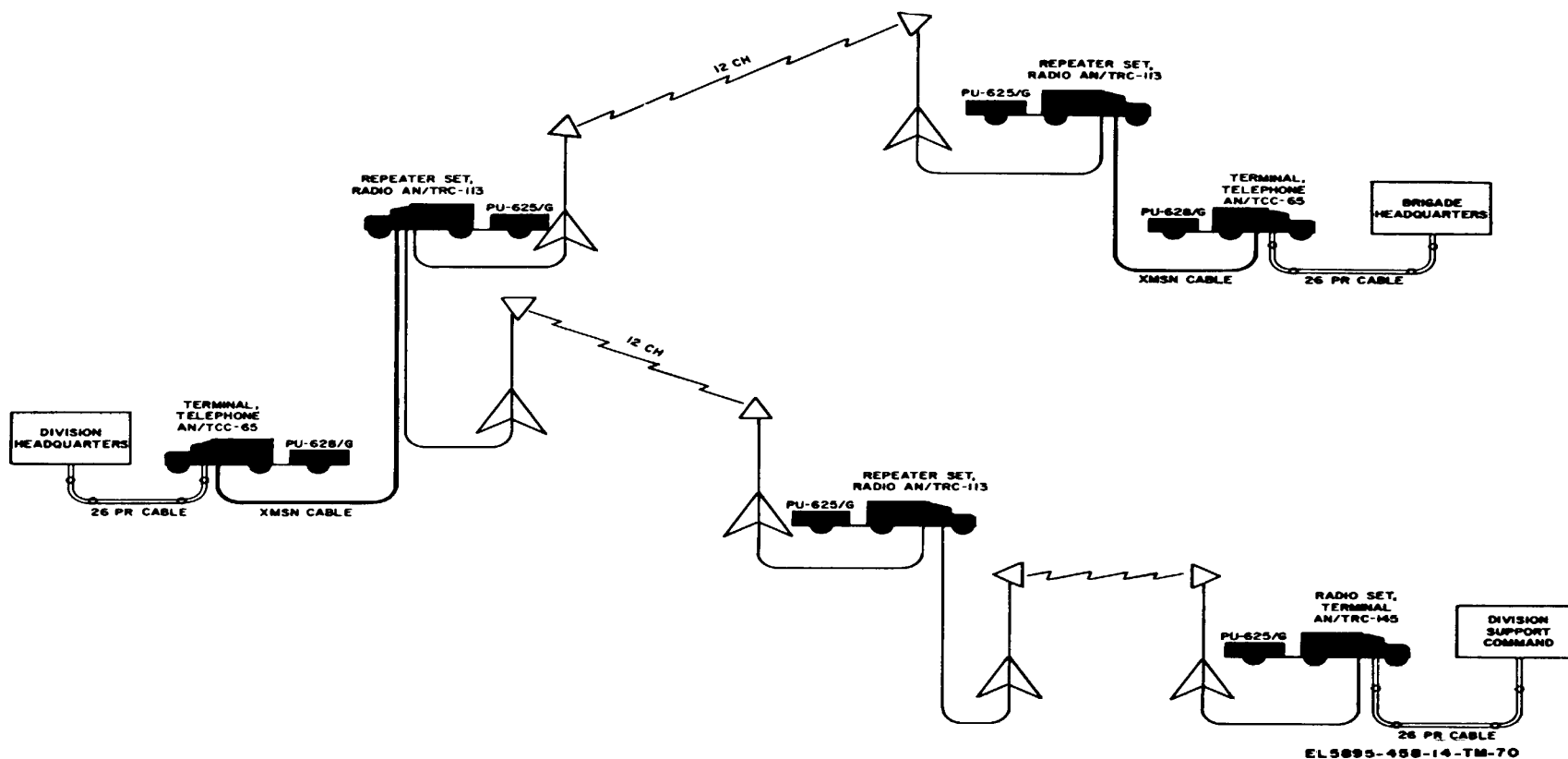
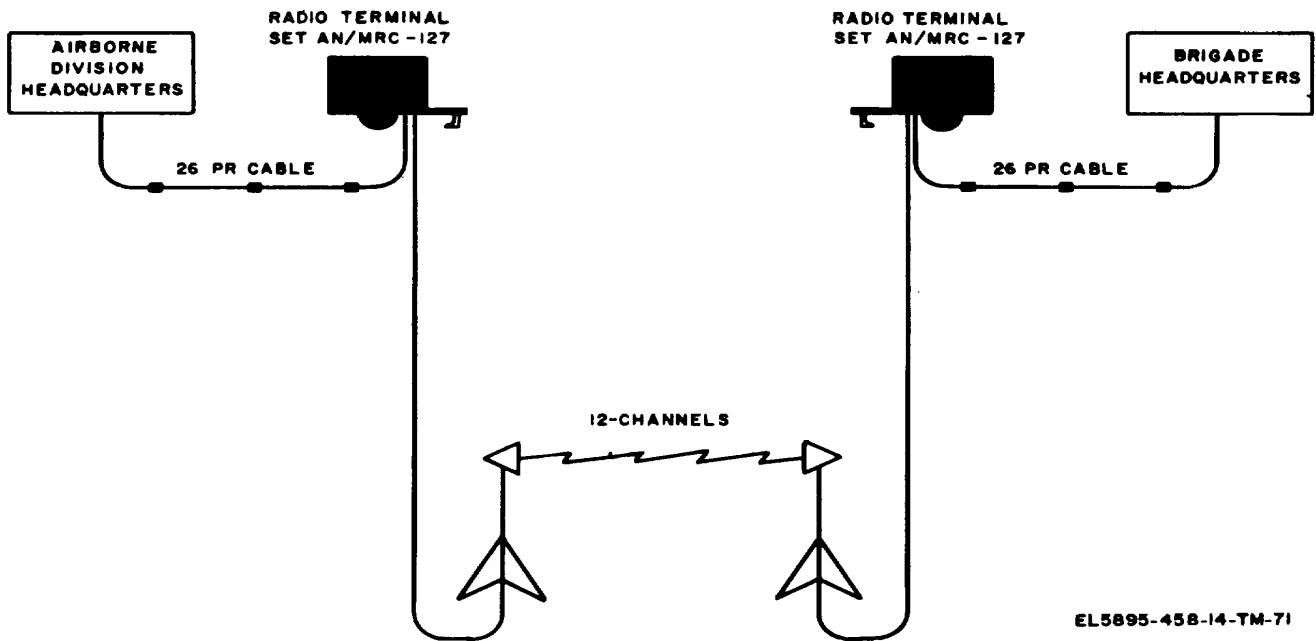
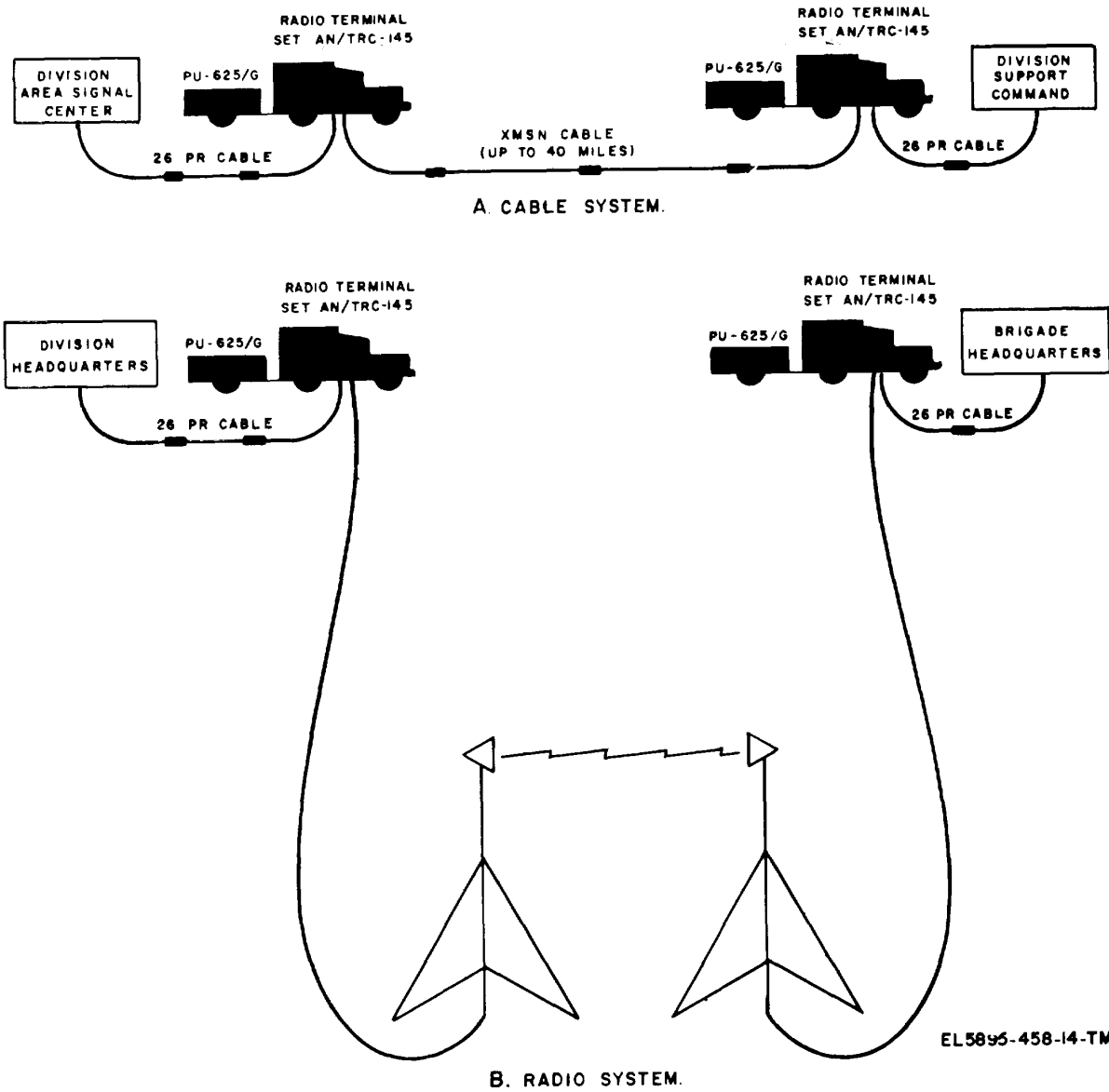

Figure 6-3. Typical applications of An/TRC-113



EL5895-458-14-TM-71

Figure 6-4 . Typical applications of AN/MRC-127.



EL5895-458-14-TM-72

Figure 6-5. Typical application of AN/TRC-145.

**6-3. Capabilities and Limitations**

Transmission medium ..... Single two-way radio or cable

Cable transmission:  
 Maximum length ..... Up to 240 miles  
 Repeater intervals:  
 Attended:  
 Maximum length ..... 40 miles of transmission  
 Minimum length ..... 1 reel of transmission cable  
 Unattended (TD-206/G)..... 1-, 1/4-, 1/2-, or 3/4- mile

option to attended repeater

Radio transmission:  
 Frequency:  
 Low band ..... 220 MHz to 404.5 MHz  
 Medium ..... 394.5 to 705.0 MHz  
 High band ..... 695.0 MHz to 1,000 MHz  
 Drop and insert (D/I)..... Available at dual 12 channel cable repeater

Remote D/I terminal distance ..... 0.25 mile minimum, 5 mile maximum  
 Range..... 50 miles or line of sight



Table 6-1. System Assemblages

Assemblage nomenclature	Major component complement													Primary employment
	T-963(P) / GRC-103(V)	R-1329(P) / GRC-103(V)	RT-775 / GRC-103(V)	TD-204 / U	TD-999(*) / G	CV-1544 / G	AS-1852 / GRC-103(V)***	AB-952 / GRC-103(V)	AM-4316 / GRC-103(V)	AM-4326 / GRC-103(V)	TSEC / KC-27	LS-147C / FI	TA-312 / PT	
Terminal Set, Telephone AN/TCC-65.	0	0	0	4*	4	4	0	0	0	0	4**	1	1	Division area signal center with cable to division support command, or with radio from division headquarters to brigade headquarters (fig. 6-2).
Repeater Set, Radio AN/TRC-113.	3	3	3	3*	0	0	1	1	1	1	0	1	1	Division headquarters to division support command to brigade headquarters by radio (fig. 6-3).
Radio Terminal Set AN/MRC-115(V).	2	2	2	0	2	2	1	1	2	2	0	0	0	Interim assemblage for multichannel terminal and repeater employment in forward area units of infantry, mechanized, armored, and airborne divisions.
Radio Terminal Sets AN/MRC-126 or AN/MRC-127	1	1	1	0	1	1	1	1	1	1	1**	0	0	Airborne division headquarters to brigade headquarters by radio (fig. 6-4).
Radio Terminal Set AN/TRC-145.	2	2	2	2*	2	2	2	2	2	2	2**	1	1	Division area signal center to division support command via cable terminal; division headquarters to brigade headquarters via radio terminal (fig. 6-5).

\*Interchangeable with TD-754.

\*\*Optional.

\*\*\*Band I indicated, substitute AS-1853 / GRC-103(V) for band II or AS-1854 / GRC-103(V) for band III.

## CHAPTER 7

## MAINTENANCE CONCEPT

## 7-1. General

a. The maintenance concept for the Low Capacity Tactical Radio Relay System provides maximum utilization of the system with minimum downtime. An assemblage technical manual is provided with each assemblage to provide complete installation and operation. Troubleshooting and repair procedures are provided in the assemblage technical manual, in accordance with the maintenance allocation chart. Defective items are forwarded to higher category maintenance where component technical manuals are available. The component technical manuals provide troubleshooting and repair procedures for DS, GS, and depot maintenance personnel. No maintenance float is provided for the shelter facilities or the assemblages, but maintenance float items are stocked at direct support as required to support the authorized organizational quantities of assemblages.

b. Each assemblage technical manual contains an "items comprising an operable equipment" paragraph which lists the items supplied for initial operation and for running spares. The list includes special tools, parts, and material issued as part of the major end item. The list includes all items authorized for basic operator maintenance of the equipment. End items of equipment are issued on the basis of allowances prescribed in equipment authorization tables and other documents that area basis for requisitioning parts.

c. Each assemblage technical manual also contains a maintenance allocation appendix that defines the type of maintenance authorized to be performed by the various maintenance categories. It authorizes specific maintenance functions on repairable item sand components and the tools and test equipment required to perform each function. This appendix may be used as an aid in planning maintenance operations. A brief description of the authorized maintenance functions for each category of maintenance is provided in paragraphs 7-2 through 7-5.

d. Each assemblage is supplied with a copy of TB750-240 which covers the authorized maintenance and repair procedures for the shelters.

## 7-2. Organizational Maintenance

a. *Operator.* An assemblage operator is authorized to perform preventive maintenance as indicated in (1) below and troubleshooting and repair as indicated in(2)below.

(1) *Preventive maintenance.* Daily preventive maintenance is performed to insure that each assemblage will have a minimum downtime. The daily preventive maintenance procedures are outlined in the assemblage technical manual and consist of the following:

- (a) Complete check for normal operation.
- (b) Making operational adjustments and alinements that do not require the use of test equipment and tools.
- (c) External cleaning of the components.
- (d) Visual inspection for damage, deterioration, and potential trouble areas.

(2) *Troubleshooting and repair.*

(a) Built-in facilities in the pcm components, and operational tests of the radio, telephone, intercom, and security components are used to isolate troubles to defective plug-in panels and subassemblies and parts in the components. The operator is authorized to replace parts that are designated as running spares in the basic issue items appendix of the assemblage technical manual.

(b) The assemblage operator is authorized to replace lamps, starters, and cable assemblies in the shelter facility.

b. *Organizational Maintenance.* The organizational maintenance personnel are authorized to perform preventive maintenance as indicated in (1) below and troubleshooting and repair as indicated in(2)below.

(1) *Preventive maintenance.* Monthly and quarterly preventive maintenance is performed to insure that each assemblage will have a minimum downtime. The monthly and quarterly preventive maintenance procedures are outlined in the assemblage technical manual and consist of the following:

- (a) Making operational adjustment sand alinement beyond the scope of the operator.
- (b) Internal cleaning of the components.
- (c) Complete inventory and requisitioning of all authorized items.

(2) *Troubleshooting and repair.*

(a) Authorized tools and test equipment are/used to isolate troubles to defective plug-in panels (that can not be isolate with the built-in test facilities in the components). Organizational maintenance personnel are authorized to replace all plug-in panels or plug-in parts in a pcm component, tubes or tuning head in a radio component, tubes in the intercom, a complete component, and replace any defective signal or power cable.

(b) Organizational maintenance personnel are authorized to repair skin punctures (with Fiberglas patches) of the shelter facility to render the facility weather tight, and make repairs on the alternating-current (ac) power distribution system. Replacement of parts not in the power distribution system is limited to easily removed parts such as gaskets, door filler; etc.

**7-3. Direct Support Maintenance**

a. Direct support maintenance personnel use authorized tools and test equipment to make adjustments and alinement beyond the scope of organizational personnel.

b. Direct support maintenance personnel are authorized to isolate troubles to and replace chassis and panel-mounted parts such as switches, fuse holders; etc., in the pcm components, but are not authorized to isolate defective parts on printed wiring board plug-in panel. Direct support maintenance personnel are authorized to isolate troubles to and replace subassemblies or chassis mounted parts in the radio components.

**NOTE**

Direct support maintenance personnel are not authorized to replace 31-pin connectors or parts mounted on printed-wiring board plug-in panels of the pcm components or parts in the subassemblies of the radio components.

c. Direct support maintenance personnel are authorized to repair all skin punctures of the shelter facility (including repair of unsound Fiberglas patches). Replacement of all parts secured with removable fasteners, such as steps, hinges, latches, etc. Is authorized.

**7-4. General Support Maintenance**

a. General support maintenance personnel use authorized tools and test equipment to make adjustments and alinements beyond the scope of direct support maintenance personnel.

b. General support maintenance personnel are authorized to isolate trouble to defective parts (resistors, capacitors; etc), except those which are part of throw away type modules that are replaced as units.

c. General support maintenance personnel are authorized to replace all defective parts or throw away type of modules and test the components to be sure that they meet the minimum user requirements for return to the using organization.

d. General support maintenance personnel are authorized complete repair of shelter facilities within their maintenance capability, providing the repairs are sufficiently sound and will not impair safe operating practices by using organizations.

**7-5. Depot Maintenance**

a. Depot maintenance personnel are authorized to overhaul or rebuild severely damaged equipment which requires shop facilities more elaborate than general support maintenance facilities.

b. Depot maintenance personnel test overhauled or rebuilt equipment to insure that it functions in accordance with the depot maintenance work requirements.

## APPENDIX

## REFERENCES

DAPam310-4	Index of Technical Manuals, Technical Bulletins, Supply Manuals (Types 7, 8, and 9), Supply Bulletins, and Lubrication Orders.
DAPam310-7	U.S. Army Equipment Index of Modification Work Orders.
SB38-100	Preservation, Packaging, Packing and Marking Materials, Supplies, and Equipment Used by the Army.
TB34-9-88	Telephone Set TA-43()/PT, Telephone Set TA-312/PT, and Telephone Set TA-5003/U.
TB760-240	Maintenance and Repair Procedures for S-141/G, S-144/G, S-250/G, S-280/G, and S-318/G Type Shelters.
TB746-10	Field Instructions for Painting and Preserving Electronics Command Equipment.
TM9-2330-251-14P	Operator's, Organizational, DS, and GS Maintenance Manual (Including Repair Parts and Special Tool Lists): Trailer, Cargo, 4-Ton, 2-Wheel, M416(2330-706-5495), M16B1(2330-017-9589); Trailer, Chassis, 1/4-Ton, 2-Wheel, M569(2330-884-4817), M569B1(2330-226-5649); Trailer, Chassis, 1/4-Ton, 2-Wheel, M762(2330-933-7462); Trailer, Cable Splicer, 1/4-Ton, 2-Wheel M716(2330-782-6062).
TM11-2057A	Test Set TS-27B/TSM
TM11-5805-201-12	Operator and Organizational Maintenance Manual, Including Repair Parts and Special Tools List: Telephone Set TA-312/PT.
TM11-5806-201-35	DS, GS, and Depot Maintenance Manual Including Repair Parts and Special Tools List: Telephone Set TA-312/PT.
TM11-5805-367-12	Operator and Organizational Maintenance Manual: Multiplexers TD-202/U, TD-03/U, TD-204/U, TD-352/U, TD-353/U, Restorer, Pulse Form TD-206/G, and Converter, Telephone Signal CV-1548/G and CV-1548A/G.
TM11-5805-367-24P/4	Organizational, DS, and GS Maintenance Repair Parts and Special Tools Lists: Restorer, Pulse Form TD-206/G.
TM11-5805-367-25P/2	Organizational, DS, GS, and Depot Maintenance Repair Parts and Special Tools Lists: Multiplexer TD-204/U.
TM11-5805-367-25P/5	Organizational, DS, GS, and Depot Maintenance Repair Parts and Special Tools Lists: Converter, Telephone Signal CV-1548/G, CV-1548A/G, and 18A4 Panel Assembly.
TM11-5805-367-35/2	DS, GS, and Depot Maintenance Manual: Multiplexer TD-204/U.
TM11-5805-367-35/4	Direct Support, General Support, and Depot Maintenance Manual: Restorer, Pulse Form TD-206/G.
TM11-5805-367-34/5	Direct Support and General Support Maintenance Manual: Converters Telephone Signal CV-1548/G and CV-1548A/G.
TM11-5805-371-15	Operator, Organizational, DS, GS, and Depot Maintenance Manual Including Repair Parts and Special Tools List: Terminal Set, Telephone AN/TCC-65.
TM11-5805-382-12	Operator and Organizational Maintenance Manual Including Repair Parts and Special Tool Lists: Multiplexers TD-660/G and TD-660A/G.
TM11-5805-382-35	Direct Support, General Support, and Depot Maintenance Manual Including Repair Parts and Special Tools Lists: Multiplexers TD-660/G and TD-660A/G, FSN 5805-930-8079.
TM11-5805-382-35P	DS, GS, and Depot Maintenance Repair Parts and Special Tools Lists: Multiplexer TD-660A/G and Dual In Line Packaging Configuration.
TM11-5805-383-12	Operators and Organizational Maintenance Manual, Including Repair Parts and Special Tools List: Multiplexer TD-754/G.
TM11-5805-383-35	Direct Support, General Support, and Depot Maintenance Manual Including Repair Parts and Special Tool Lists: Multiplexer TD-754/G.
TM11-5820-540-12	Operators and Organizational Maintenance Manual Including Repair Parts and Special Tool Lists: Radio Set AN/GRC-103(V)1, 2, and 3 and Extension Kit, Mast MK-1009/GRC-103(V).
TM11-5820-540-35	DS, GS and Depot Maintenance Manual: Radio Sets AN/GRC-103(V)1, 2, and 3.
TM11-5820-540-35P	Direct Support, General Support, and Depot Maintenance Repair Parts and Special Tools List: Radio Set AN/GRC-103(V)1: Mast Extension Kit, and Direct Support Cable Kit.
TM11-5820-562-14	Operator, Organizational, Direct Support, and General Support Maintenance Manual Including Repair Parts and Special Tools Lists: Repeater Sets, Radio AN/TRC-113(V)1, AN/TRC-113(V)2, AN/TRC-113(V)3, AN/TRC-3A(V)1, AN/TRC-113A(V)2, and AN/TRC-113A(V)3 (FSN 5820-868-8211).



TM11-56890-221-12	Operators and Organizational Maintenance Manual: Intercommunications Station LS-147A/FI,LS1417B/F1,LS-f47C/FI,andLS-147D/FI.
TM11-6580221-24P	Organizational, Direct Support ,and General Support Maintenance Repair Part and Special Tools Lists(Including Depot Maintenance Re Parts and Special Tools): Intercommunications Station LS-147C/FIFSN5830-752-6537.
TM11-890-221-56	Field and Depot Maintenance Manual: Intercommunication StationsLS-147A/FI,LS. 147B/FI,LS-147C/FI,andLS-147D/FI.
TM11-5896-453-14	Operator's Organizational, Direct Support and General Support Maintenance Manual Including Repair Parts and Special Tools List: Radio Terminal Set AN/TRC-145(V)1, AN/TRC-145(V)2, AN/TRC-145(V)3, AN/TRC-145A(V)1, AN/TRC.145A(V)2, and AN/TRC-145A(V)3, (FSN5895-791-3366).
TM11-5896-585-15	Operator, Organizational, DS,GS, and Depot Maintenance Manual Including Repair Parts and Special Tools Lists: Radio Terminal Set AN/MRC-116(V).
TM11-5896-694-15	Operator's Organizational, DS, and GS Maintenance Manual Including Repair Parts and Special Tools List: Radio Terminal Sets AN/MRC-126andAN/MRC-127.
TM114625-648-12	Operators and Organizational Maintenance Manual: Test Set,TelephoneAN/PTM-7.
TM38-750	The Army Maintenance Management System(TAMMS).
TM38-75	

---

**GLOSSARY**

---

*Assemblage*-Complete end item equipment including shelter or trailer facility, all operating components, and interconnecting cables.

*Shelter*-Shelter, Electrical Equipment S-260/G and S-369/GRC.

*Shelter facility*-A shelter, modified to contain (but not include) components and interconnecting cable.

The shelter facility contains a completely installed ac power. Distribution system, equipment racks secured to the floor and walls, and signal wiring, but does not include the communications equipment.

*Trailer facility*-A trailer, modified to contain (but not include) components and interconnecting cables. The trailer facility contains a completely installed ac power distribution system, equipment racks secured to the floor, and signal wiring but does not include the communications equipment.

By Order of the Secretary of the Army:

CREIGHTONW.ABRAMS,  
*General, United States Army,,  
 Chief of Staff.*

Official  
 VERNEL.BOWERS  
*Major General, United States Army,  
 The Adjutant General.*

Distribution:

Active Army

USASA(2)	Fort Gordon(10)
CNGB(1)	Fort Huachuca (10)
Dir of Trans(1)	WSMR(1)
COE(1)	Fort Carson(5)
TSG(1)	Ft Richardson(ECOM Ofc)(2)
USAARENBD(1)	Army Dep(1)except:
AMC(1)	LBAD(14);
TRADOC(2)	SAAD(30);
ARADCOM(2)	TOAD(14);
ARADCOMRgn(2)	ATAD(10);
OS Maj Comd(4)	USA Dep(2)
LOGCOMDS(3)	Sig Sec USA Dep(2)
MICOM(2)	Sig Dep(2)
TECOM(2)	Sig FLDMS(1)
USACC(4)	USAERDAA(1)
MDW(1)	USAERDAW(1)
Armies(2)	MAAG(1)
Corps(2)	USARMIS(1)
HISA(Ft Monmouth)(43)	Units org under fol TOE
Svc Colleges(1)	(2cyseachunit):
USACESS(5)	11-3;
USASESS(10)	11-205;
USAADS(2)	11-215;
USAFAS(2)	11-237;
USAARMS(2)	29-15;
USAIS(2)	29-55;
USAES(2)	29-85;
USAINTCS(3)	29-134;
WRAMC(1)	44-235;
ATS(1)	4-6535.

NG: None

USAR: None

For explanation of abbreviations used, see AR310-50.

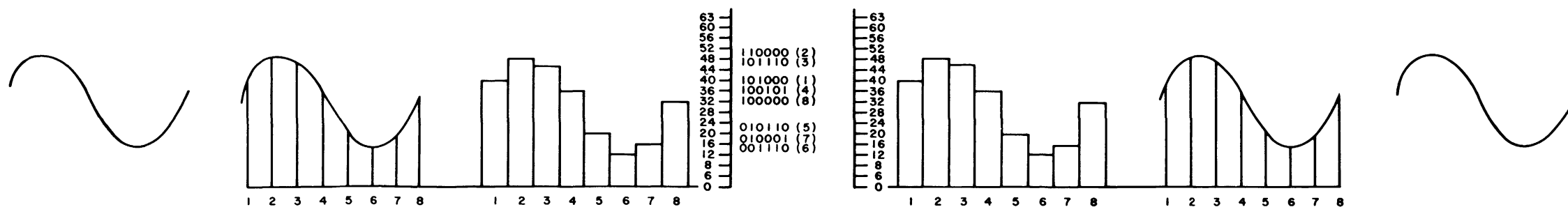
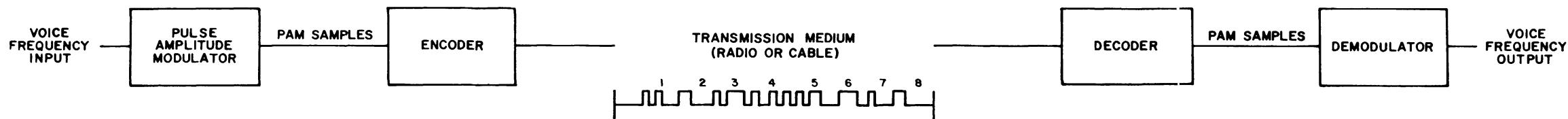



Figure FO-1. Voice transmission by pulse code modulation.



RECOMMENDED CHANGES TO EQUIPMENT TECHNICAL PUBLICATIONS

 <p style="font-size: 1.2em; font-weight: bold; margin: 0;">SOMETHING WRONG WITH THIS PUBLICATION?</p>		FROM: (PRINT YOUR UNIT'S COMPLETE ADDRESS)		
		DATE SENT		
PUBLICATION NUMBER TM 11-5825-270-10		PUBLICATION DATE 23 Jul 81	PUBLICATION TITLE Radio Frequency R-2176/FRN	
BE EXACT... PIN-POINT WHERE IT IS				
PAGE NO.	PARA-GRAPH	FIGURE NO.	TABLE NO.	IN THIS SPACE TELL WHAT IS WRONG AND WHAT SHOULD BE DONE ABOUT IT:
PRINTED NAME, GRADE OR TITLE, AND TELEPHONE NUMBER			SIGN HERE:	

TEAR ALONG PERFORATED LINE

**DA FORM 2028-2**  
1 JUL 79

PREVIOUS EDITIONS ARE OBSOLETE.

P.S.—IF YOUR OUTFIT WANTS TO KNOW ABOUT YOUR RECOMMENDATION MAKE A CARBON COPY OF THIS AND GIVE IT TO YOUR HEADQUARTERS.

**PIN: 014620-000**